

**Report 2008-1**

**Carbon dioxide sequestration by  
mineral carbonation  
Literature review update 2005–2007**



**Johan Sipilä, Sebastian Teir and Ron Zevenhoven**

**Carbon dioxide sequestration by  
mineral carbonation  
Literature review update 2005–2007**

**Johan Sipilä<sup>1</sup>, Sebastian Teir<sup>2</sup>, Ron Zevenhoven<sup>1</sup>**

<sup>1</sup> Åbo Akademi University, Heat Engineering Laboratory ([web.abo.fi/tkf/vt](http://web.abo.fi/tkf/vt)), Turku, Finland

<sup>2</sup> Helsinki University of Technology, Laboratory of Energy Engineering and Environmental Protection ([eny.tkk.fi](http://eny.tkk.fi)), Espoo, Finland

The authors gratefully acknowledge the final support of Shell Global Solutions International BV for the preparation of this literature review.

## Preface

This review report is intended to list and summarise the current research and development (R&D) around mineral carbonation for long-term storage of CO<sub>2</sub> as it has been published in the open literature (in journal articles, conference proceedings, patents etc.) during the three-year period from January 2005 to December 2007.

Literature published prior to January 2005 is marked with a ‘†’ whenever cited, so as to distinguish between information that might have already been considered in earlier literature reviews but should be mentioned here. As the task was to produce a follow-up to the three review reports that were published earlier [1†,2†,3] a similar organisation and lay-out style was adopted. The production of this report was financially supported by Shell Global Solutions International BV.

## Abstract

The field of mineral sequestration for the long-term storage of carbon dioxide is a CCS (carbon dioxide capture and storage) option that provides an alternative for the more widely advocated method of geological storage in underground cavities, especially at locations where such underground cavities are not available, where the risk of leakage of the CO<sub>2</sub> stored underground is considered unacceptable, or where large resources of material suitable for carbonation are present. Although the state of the art of mineral carbonation processing technically suffers from too slow chemical kinetics and poor energy economy, the driving forces for continued attention for this CCS route are its sheer capacity (dwarfing other CCS methods), the fact that it gives compact and leakage-free CO<sub>2</sub> fixation that needs no post-storage monitoring and finally the potential of operating at a zero (or negative) net energy input, provided that the process is properly optimised, and utilises the benefits of favourable thermodynamics. Despite partial successes and promising process ideas, so far the keys to success have not been found. While work on this subject did not start until the 1990s, earlier literature reviews have considered the period until 2000 [1†], the period until 2003 [2†] and the years 2003-2004 [3]. As already noted in the previous review, the increasing worldwide interest in mineral carbonation (demonstrated, for example, by the number of contributions to the latest GHGT conferences) has motivated the prompt production of the next literature review.

The information collected and presented here shows that mineral carbonation R&D found its way to an increasing number of countries, and that besides carbonation of magnesium- or calcium-based minerals especially the carbonation of waste materials and industrial by-products is expanding. Currently the main route for carbonation uses aqueous solutions, either “direct”, where an additive is used to achieve the required chemical reaction rate, or “indirect” where extraction of Mg or Ca and the subsequent carbonation of that are separate process steps that are optimised independently. Depending on whether purpose of the goal is to bind large amounts of CO<sub>2</sub>, or produce a carbonate material, the methods, process parameters, input materials and additives vary widely depending on what cost level is considered acceptable. One aspect addressed in some more detail in this report is energy efficiency, showing that the costs of process heat input are significantly over-estimated when charged the same way as power input, giving a false impression of overall process economics. For large-scale CO<sub>2</sub> sequestration using magnesium silicates the aqueous route developed in the U.S. is still the most successful one, with a cost level at above 40 €/t CO<sub>2</sub>. Work on stepwise carbonation of serpentine with the exothermic carbonation step conducted at high temperatures and pressures is ongoing in Finland.

# Contents

<b>1</b>	<b>INTRODUCTION TO CO<sub>2</sub> SEQUESTRATION.....</b>	<b>1</b>
1.1	GEOLOGICAL STORAGE .....	1
1.2	OCEAN STORAGE .....	2
1.3	STORAGE BELOW SEA BED .....	3
1.4	MINERAL CARBONATION – OVERVIEW OF THE TECHNOLOGY .....	3
1.5	A SHORT HISTORY OF MINERAL CARBONATION DEVELOPMENT WORK UNTIL 2005.....	8
1.6	MINERAL CARBONATION - CURRENT STATE OF THE ART.....	10
<b>2</b>	<b>PROCESS ROUTES FOR MINERAL CARBONATION .....</b>	<b>12</b>
2.1	DIRECT CARBONATION .....	12
2.1.1	<i>Direct gas-solid carbonation.....</i>	<i>12</i>
2.1.2	<i>Direct aqueous carbonation.....</i>	<i>14</i>
2.2	INDIRECT CARBONATION .....	22
2.2.1	<i>Multistage gas-solid carbonation route .....</i>	<i>23</i>
2.2.2	<i>Acetic acid route.....</i>	<i>24</i>
2.2.3	<i>Two-step aqueous carbonation.....</i>	<i>25</i>
2.2.4	<i>Indirect aqueous carbonation - Other leaching enhancing additives .....</i>	<i>28</i>
2.3	OTHER PROCESSES AND CO <sub>2</sub> APPLICATIONS .....	30
2.3.1	<i>The production of precipitated calcium carbonate .....</i>	<i>30</i>
2.3.2	<i>Carbonation using brines.....</i>	<i>30</i>
2.3.3	<i>Accelerated weathering of limestone.....</i>	<i>31</i>
2.3.4	<i>Straightforward carbonation.....</i>	<i>32</i>
2.4	PRE-TREATMENT OPTIONS .....	33
2.5	COMPARING TECHNOLOGIES .....	34
<b>3</b>	<b>DISCUSSION AND CONCLUSIONS.....</b>	<b>37</b>
<b>4</b>	<b>BIBLIOGRAPHY .....</b>	<b>39</b>
	<b>APPENDIX.....</b>	<b>48</b>
	ENERGY EFFICIENCY OF MINERAL CARBONATION PROCESSES.....	48

cover picture: Svartisen glacier in northern Norway  
 (photo RZ, July 2007)

## List of abbreviations

AOD = Argon-oxygen decarburisation

APC = Air pollution control

ARC = Albany Research Center

AWL = Accelerated weathering of limestone

BOF = Basic oxygen furnace

BSE = Backscatter electron

CCS = Carbon dioxide capture and storage

CFBC = Circulating fluidized bed combustion

CO<sub>2</sub> = Carbon dioxide

ECBM = Enhanced Coal Bed Methane recovery

EOR = Enhanced Oil Recovery

FB = Fluidized bed

FGD = Fluegas desulphurisation

HT = Heat treated

L/S = Liquid to solid ratio

LANL = Los Alamos National Laboratory

MSWI = Municipal solid waste incinerator

NGCC = Natural gas combined cycle

PCC = Precipitated calcium carbonate

PF = Pulverized fuel firing

PSD = Particle size distribution

SEM-EDX = Scanning electron microscope-Energy dispersive x-ray

SMD = Stirred media detritor

TKK = Helsinki University of Technology (“Teknillinen korkeakoulu”)

$R_{CO_2}$  = Theoretical amount of a given mineral to convert a unit mass of CO<sub>2</sub> into carbonate [4†]

$R_x$  = Conversion efficiency (*e.g.* fraction of Mg in Mg<sub>2</sub>SiO<sub>4</sub> converting to MgCO<sub>3</sub>)

# 1 Introduction to CO<sub>2</sub> sequestration

Carbon dioxide (CO<sub>2</sub>) is the most common component of the earth's atmosphere after nitrogen, oxygen, and argon, when water vapour is disregarded. The amount of CO<sub>2</sub> in the atmosphere has increased significantly and rapidly in recent years reaching 384<sup>1</sup> ppm in 2007, with an annual mean growth rate of almost 2<sup>1</sup> ppm since 2000. The steep increase in atmospheric CO<sub>2</sub> concentration is alarming, and it has been attributed as a major factor in the increase in the earth's temperature. In other words, CO<sub>2</sub> must be considered the most important greenhouse gas, as it has the largest volume and is the fastest increasing greenhouse gas known today.

In order to avoid the potentially devastating consequences of global warming and climate change, the CO<sub>2</sub> emissions into the atmosphere caused by human (*i.e.* anthropogenic) activities should be reduced considerably [5]. There are several suggestions as to how to achieve this reduction, but none of the suggestions/technologies for what is known as carbon dioxide capture and storage (CCS) (see Figure 1.1) have yet been able to meet the enormous demand for reduction. Nonetheless, extensive R&D activities are ongoing which in a few cases, such as geological storage in underground cavities, have reached a demonstration scale (storing several Mt CO<sub>2</sub> annually).

## 1.1 Geological storage

One of the technologies, that has already been employed on a significant scale, but not large enough to have a global CO<sub>2</sub> emissions mitigation impact, (*e.g.* in Colorado, USA and Weyburn, Canada) is storage of CO<sub>2</sub> in underground cavities. This includes the so-called Enhanced Oil Recovery (EOR) and also Enhanced Gas Recovery (EGR), which are concepts aimed at improving the oil/gas recovery potential of an oil/gas field by flooding it with CO<sub>2</sub>. Traditionally, this is accomplished with CO<sub>2</sub> obtained from natural storage, and to a smaller extent using CO<sub>2</sub> produced by human activities involving fossil fuel use [6].

A well-known demonstration project is the Sleipner project operating in Norway, where CO<sub>2</sub> is separated off-shore from natural gas produced at a gas field in the North-Sea and is pumped into an underground aquifer below the sea bottom, at a lesser depth than the gas field. Since the mid-1990s, around 1 Mt of CO<sub>2</sub> has been sequestered annually at this site. Although this activity is only on a minor scale when considering the multi-Gt CO<sub>2</sub> per annum effort that is needed to stop the currently ongoing global warming and climate change, similar demonstration projects have since started in Canada (mentioned above), Algeria, Australia and several other locations, including a second site in Norway [6].

---

<sup>1</sup> Globally averaged marine surface data [119].

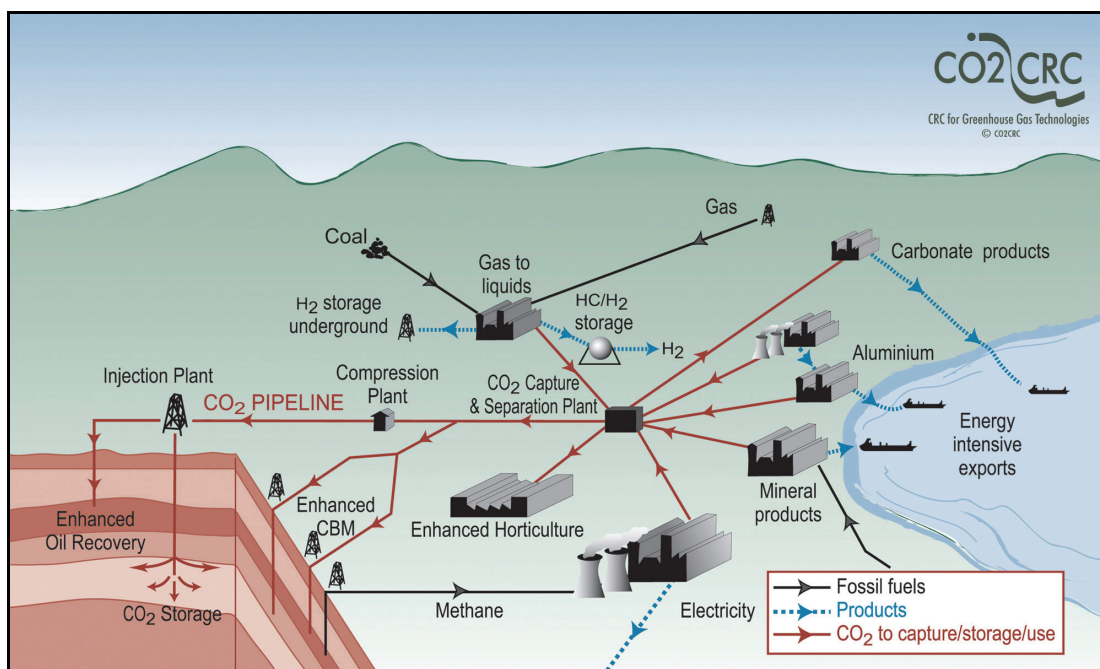

Figure 1.1. Schematic diagram of various CCS alternatives [7].

Besides EOR/EGR, which combines CO<sub>2</sub> storage with fossil fuel recovery, a similar alternative for preventing CO<sub>2</sub> from entering the atmosphere is Enhanced Coal Bed Methane recovery (ECBM). Here the purpose is to inject CO<sub>2</sub> into a coal seam so as to displace methane, which can then be recovered. Both EOR/EGR and ECBM are geological storage options, which also include the direct injection into any other underground reservoir, such as an abandoned gas/oil field or an underground saline formation.

Perhaps the greatest problem/challenge related to underground storage is the permanency of the solution, as there will always be a risk of leakage<sup>2</sup>. Therefore, this solution would require continuous monitoring of storage sites for thousands of years<sup>3</sup>.

## 1.2 Ocean storage

Another widely studied option for CO<sub>2</sub> sequestration involves injecting CO<sub>2</sub> into the ocean, preferably at great depths, where the gaseous CO<sub>2</sub> reacts to form carbonic acid (H<sub>2</sub>CO<sub>3</sub>). The

<sup>2</sup> “Even if only one per cent of the remaining carbon dioxide were to leak out every thousand years, it could still pose a threat. That would mean the loss of 87 per cent in 200,000 years, with the result that more carbon dioxide was released into the atmosphere and the seas than if CCS had not been implemented, since the energy consumed in capturing and storing carbon dioxide means that more coal has to be burned.” [120].

<sup>3</sup> A scenario analysed in IEA [121] for cost estimations, however, considers only 20 years of monitoring after 30 years of injection in a saline aquifer (see Table 2.6, p.34).



carbonic acid then dissociates into a (bi)carbonate ion and hydrogen ion in accordance with the equation below: [6]

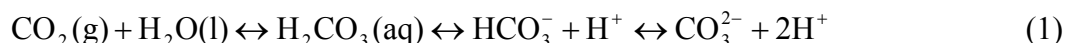

Although ocean storage could provide a fast and relatively easy alternative for CO<sub>2</sub> emissions reduction it has lost its appeal in recent years, largely due to the uncertainty when considering the environmental consequences (*e.g.* decreasing pH of ocean water) and the lack of permanency (natural ocean turnover time is measured in centuries) [5,8].

### 1.3 Storage below sea bed

An alternative to both geological storage and ocean storage described above is carbon dioxide storage below the ocean floor at depths of at least 3,000 m of ocean and several hundred meters of marine sediment. In contrast to the previously mentioned options this option does not suffer from lack of permanency (ocean storage) or the demand for monitoring the storage site (geological storage). The idea is based on the fact that CO<sub>2</sub> becomes denser than water at sufficient depths ( $\approx 3,000$  m), but that it still needs to be trapped in order to prevent it from being released by ocean currents or *e.g.* earthquakes. Therefore, it should be stored below the seabed where it would initially be trapped by a more buoyant pore fluid forming a kind of buoyancy cap. Given enough time, however, CO<sub>2</sub> would become more buoyant than the pore fluid due to the geothermal gradient, but fortunately as a result of the conditions (high pressure and low temperature) the CO<sub>2</sub> is further trapped by the formation of CO<sub>2</sub> hydrates, which clog the pore channels of the sea bed sediment. [9]

This alternative is still new and further research is ongoing in order to verify the theories. For more information see *e.g.* [9].

### 1.4 Mineral carbonation – overview of the technology

Even though ocean storage of CO<sub>2</sub> has increasingly become an unattractive alternative, the reaction sequence in Equation (1) is still interesting considering other potential CO<sub>2</sub> sequestration alternatives, such as *in situ* or *ex situ* mineral carbonation. *In situ* mineral carbonation is closely connected<sup>4</sup> to the underground storage option as it involves the injection of CO<sub>2</sub> into underground reservoirs. The difference is that, *in situ* mineral carbonation explicitly aims at producing a reaction with the CO<sub>2</sub> to form carbonates with alkaline-minerals present in the geological formation. The

---

<sup>4</sup> Understanding the carbonation reaction is extremely important to both *in situ* and above ground CO<sub>2</sub> sequestration [67,70].

reaction between a metal oxide bearing material (see Table 1.2 below) and CO<sub>2</sub> is called carbonation and can be expressed by the following reaction:



where in practice M describes a (metallic) element such as calcium, magnesium or iron. The reaction in Equation (2) is exothermic and the heat released is dependent on the metallic element bearing mineral at hand (for the magnesium- or calcium-based silicate minerals olivine: 89 kJ/mol CO<sub>2</sub>, serpentine: 64 kJ/mol CO<sub>2</sub> and wollastonite: 90 kJ/mol CO<sub>2</sub> at 298 K). [6]

One major benefit of CO<sub>2</sub> sequestration by mineral carbonation consist of the environmentally benign and virtually permanent<sup>5</sup> trapping of CO<sub>2</sub> in the form of carbonated minerals by using abundant mineral resources such as Mg-silicates [6]. Unlike other CO<sub>2</sub> sequestration routes it provides a leakage-free long-term sequestration option, without a need for post-storage surveillance and monitoring once the CO<sub>2</sub> has been fixed. In a recent study, Teir *et al.* [10] investigated the stability of calcium and magnesium carbonate when subjected to an acidic aqueous environment (such as acidic rain). The conclusion of the study was that Ca/Mg carbonates should be resistant enough to prevent local environmental effects at a mineral carbonate storage site.

In addition to the benefits of mineral carbonation, this option is the only CO<sub>2</sub> sequestration option available where large underground reservoirs do not exist and ocean storage of CO<sub>2</sub> is not feasible, *e.g.* Finland [11†] and Korea [12]. In Lithuania and the Baltic region in general [13], alternatives to *in situ* CO<sub>2</sub> trapping are also being explored, as the saline aquifers in Lithuania have been found unsuitable for CO<sub>2</sub> storage [14].

Another benefit of mineral carbonation is that, at least theoretically<sup>5</sup>, the carbonation process could proceed without energy input, but this has not yet been accomplished. In fact, many of the carbonation processes presented to date suffer from being too energy demanding and expensive. The largest challenge has perhaps been, and still is, to enhance the otherwise extremely slow (hundred thousands of years in nature) carbonation reaction, without excessive overall process costs.

Attempts to speed up the carbonation reaction include using both dry and wet methods, additives, heating and pressurising the carbonation reactor, dividing the process into multiple steps, pre-treatment of the mineral source and more. Still, none of the methods have proven to be both economically and environmentally viable due to various difficulties related to mineral carbonation. Consider for example the reaction temperature; increasing the temperature in a process is known to enhance reaction rates. However, thermodynamics puts restraints on the stability of carbonates and

---

<sup>5</sup> Carbonates have a lower thermodynamic energy state (*i.e.* are more stable in nature) than CO<sub>2</sub>.

the temperature can only be increased to a certain level (which is pressure dependent) before the formation of CO<sub>2</sub> is favoured over carbonates: for example at CO<sub>2</sub> pressures of 1 bar MgCO<sub>3</sub> is stable up to temperatures of around 400 °C and at 35 bar CO<sub>2</sub>, MgCO<sub>3</sub> is stable up to around 550 °C [15]. Therefore a simple solution of increasing temperature (and making use of the exothermic high temperature carbonation reaction) until reaction rates are sufficiently fast would not work without pressurisation and other (indirect) routes have to be investigated.

Another factor to consider is that large-scale sequestration of CO<sub>2</sub> from flue gases as mineral carbonates will require vast amounts of mineral: 1 kg of CO<sub>2</sub> may require 2 kg (or more) of serpentine for disposal, which certainly results in significant environmental impact at the disposal site [15]. On the other hand, a process for storing several Mt of CO<sub>2</sub> per annum will involve solids handling of a scale similar to a typical (see Table 1.1) metal ore or mineral mining and processing activity.

Table 1.1. Examples of mining activities around the world [16].

<b>Name/Location</b>	<b>Mining activity</b>	<b>Ore mining rate (Mt/y)</b>
Escondida/Chile	Copper	374
Morenci/USA	Copper	256
Antamina/Peru	Copper, Zinc	123
Venetia/South Africa	Diamond	70
Malmberget, Kiruna/Sweden	Iron	37

### ***Calcium and magnesium (and iron) sources for mineral carbonation***

There are several different elements that can be carbonated, but alkaline earth metals, calcium and magnesium, have proven to be the most suitable due to their abundance and insolubility in nature. Iron has also been suggested for carbonation, but as it is a valuable mineral resource sought after for other purposes, it is less suitable for large-scale carbonation implementations [3]. In addition to the abundant magnesium and calcium containing minerals, there are also industrial solid residues that contain large amounts of Mg, Ca and even Fe. Below are three Tables of various materials investigated in the articles reviewed in this report.

Table 1.2. Mineral types investigated for carbonation in research papers and reports (2005-07).

MINERAL	FORMULA/COMPOSITION	REFERENCE
Basalt		[57] <sup>b</sup> [83]
Eclogite		[39]
Feldspar	CaAl <sub>2</sub> Si <sub>2</sub> O <sub>8</sub>	[83]
Forsterite	Mg <sub>2</sub> SiO <sub>4</sub>	[64]
Glauconite <sup>a</sup>	(K, Na, Ca) <sub>1.2-2.0</sub> (Fe <sup>3+</sup> , Al, Fe <sup>2+</sup> , Mg) <sub>4.0</sub> x [Si <sub>7-7.6</sub> Al <sub>1-1.4</sub> O <sub>20</sub> ](OH) <sub>4</sub> nH <sub>2</sub> O	[115]
Ilmenite	FeTiO <sub>3</sub>	[39]
Listwanite	Carbonated serpentinite	[70] <sup>c</sup>
Magnetite	Fe <sub>3</sub> O <sub>4</sub>	
Olivine	(Mg, Fe) <sub>2</sub> SiO <sub>4</sub>	[21,22,39,49,50,64,67,71,77,78,81,83,84,90,101,102,104,108][72,73] <sup>d</sup>
Opoka <sup>a</sup>	mainly CaCO <sub>3</sub> , SiO <sub>2</sub> , hematite and muscovite	[115]
Pyroxene	CaMgSi <sub>2</sub> O <sub>6</sub> + (Fe, Al)	[83]
Serpentine <sup>f</sup>	Mg <sub>3</sub> Si <sub>2</sub> O <sub>5</sub> (OH) <sub>4</sub>	[12,14,22,35,50,64,67,83,85,93,105,108,116,117]
Serpentinite		[56] <sup>c</sup> [59,74,87,92]
Talc	Mg <sub>3</sub> Si <sub>4</sub> O <sub>10</sub> (OH) <sub>2</sub>	[12,83,105]
Wollastonite	CaSiO <sub>3</sub>	[22,51,57,58,79,83,87,106,108,118]

<sup>a</sup> Not suitable for mineral carbonisation due to high content of carbonates [115].

<sup>b</sup> Basalt (%): SiO<sub>2</sub>: 49.20, TiO<sub>2</sub>:1.84, Al<sub>2</sub>O<sub>3</sub>: 15.74, Fe<sub>2</sub>O<sub>3</sub>: 3.79, FeO: 7.13, MnO: 0.20, MgO: 6.73, CaO: 9.47, Na<sub>2</sub>O: 2.91, K<sub>2</sub>O: 1.10, P<sub>2</sub>O<sub>5</sub>: 0.35

<sup>c</sup> 83 wt% serpentine and 17 wt% magnetite (Fe<sub>3</sub>O<sub>4</sub>)

<sup>d</sup> Mg<sub>1.82</sub>Fe<sub>0.18</sub>SiO<sub>4</sub>

<sup>e</sup> Studying reactions leading to the formation of listwanite

<sup>f</sup> Further categorized into different mineral types: Chrysotile, lizardite and antigorite

Table 1.3. Materials (synthetic) investigated in research papers and reports (2005–07).

MATERIAL	FORMULA/COMPOSITION	REFERENCE
Brucite	Mg(OH) <sub>2</sub>	[24,25,35,37,50,52]
Calcium silicate	CaSiO <sub>3</sub> , Ca <sub>2</sub> SiO <sub>4</sub>	[24,25]
Caustic lime	CaO	[24,25]
Enstatite	MgSiO <sub>3</sub>	[24,25]
Forsterite	Mg <sub>2</sub> SiO <sub>4</sub>	[24,25,49]
Hydromagnesite	(MgCO <sub>3</sub> ) <sub>4</sub> · Mg(OH) <sub>2</sub> · 4H <sub>2</sub> O	[52,67]
Limestone	CaCO <sub>3</sub>	[99], [10] <sup>a</sup>
Magnesia	MgO	[24,25,35,37]
Magnesite	MgCO <sub>3</sub>	[10] <sup>a</sup>
Merwinite	Ca <sub>3</sub> Mg(SiO <sub>4</sub> ) <sub>2</sub>	[24,25]
Nesquehonite	MgCO <sub>3</sub> · 3H <sub>2</sub> O	[52,67]
Slaked lime	Ca(OH) <sub>2</sub>	[24,25,75,94]
	(Ca,Na) <sub>2</sub> (Mg,Al)(Si,Al) <sub>3</sub> O <sub>7</sub>	[24,25]

<sup>a</sup> Stability (not CO<sub>2</sub> binding capacity) was tested

Table 1.4. Solid residue materials investigated for carbonation purposes (two left columns) and references not related to specific mineral studies (see comment column) in research papers and reports published 2005–07.

<b>MATERIAL</b>	<b>REFERENCE</b>	<b>OTHER REFS INCLUDED</b>	<b>COMMENT</b>
AOD process slag	[58,87]	[3,5,6,8,13,15,19,55,109]	Review type
APC ash	[23,62]	[68,69,91]	Abstract only
Blast furnace slag	[58,60,86,87]	[17]	Mineral resource study
Brine	[96,97]	[9]	Geological sequestration
CFBC ash	[24,25]	[16,119]	Other
Contaminated land	[21]	[65]	No experimental data
Electric arc furnace slag	[58,87]		
Lignite fly ash	[76][97] <sup>a</sup>		
Mining waste/tailings	[39,103]		
MSWI bottom ash	[21,54,61]		
Paper bottom ash	[89]		
PF ash	[24,25]		
Steel converter slag	[58,87]		
Steel slag	[20,51,66,86,89,100,106] [21] <sup>b</sup>		
Waste cement	[88,100,118]		

<sup>a</sup> Six different types of fly ashes were used

<sup>b</sup> Slags in general

From the tables above it can be concluded that currently the most investigated mineral resources are olivine, serpentine and wollastonite. From the solid residues in Table 1.4, steel slag has recently received a lot of attention as well.

In order to theoretically compare the CO<sub>2</sub> binding capacity of a mineral source, Goff and Lackner [4†] introduced the concept of  $R_{CO_2}$ .  $R_{CO_2}$  gives the theoretical mass amount of a given mineral necessary to convert a unit mass of CO<sub>2</sub> into mineral carbonate; the lower the  $R_{CO_2}$ -value, the less mineral is required for carbonation (see Table 2.8 on p. 36 for examples of  $R_{CO_2}$ -values).

The amounts of Mg and Ca sources are vast, but as mineral carbonation research continues to expand the need for a detailed worldwide evaluation of the amounts of suitable mineral deposits becomes more important [3]. A recently conducted evaluation of mineral reserves in the U.S. concluded that mineral resources are unlikely to be a limiting factor when industrial scale mineral sequestration is considered [17]. It was conservatively (taking into account several social, economic and political factors) estimated that there is enough material to sequester the total U.S. (current level) CO<sub>2</sub> emissions for more than 120 years.

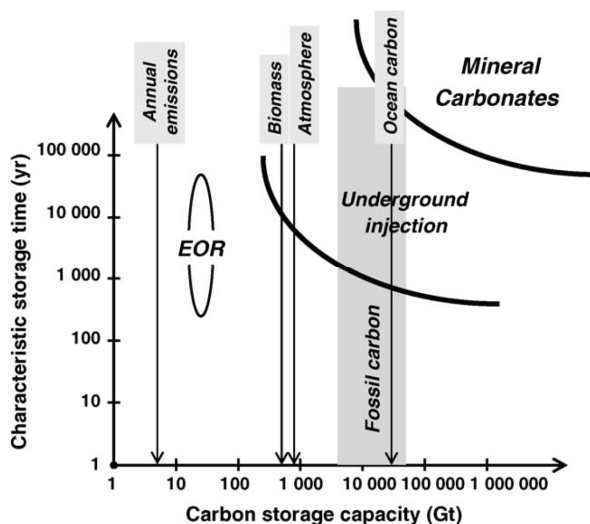

Figure 1.2. Estimated storage times and capacities for various CO<sub>2</sub> sequestration methods ([15] after [18†]).

From the above Figure it can be seen that calcium and magnesium containing minerals have been found to exist in vast quantities around the world<sup>6</sup>. In addition to natural mineral deposits, there are also numerous other sources containing both magnesium and calcium that could be utilized for carbonation. In the literature review by Huijgen and Comans [3,19] it was concluded that several solid residues are particularly suitable for niche applications of CO<sub>2</sub> sequestration. The unstable nature and potentially higher reactivity of many calcium-containing industrial residues could allow for the first CO<sub>2</sub> sequestration (demonstration) plants to become reality [20] based on using these materials. In addition treating waste products with CO<sub>2</sub> has the possibility of rendering *e.g.* heavy metals immobile, as suggested by Bertos *et al.* [21]. Industrial residues or by-products that have been studied for the purpose of carbonation include: asbestos-mining tailings, electric arc furnace (EAF) dust, steel-making slag, cement-kiln dust, waste concrete, coal fly ash [22], air pollution control (APC) residues [23], pulverized fuel firing (PF) and circulating fluidized bed combustion (CFBC) ashes [24] as well as ash transportation waters [25]. See Tables 1.2–1.4 for a list of materials investigated for carbonation purposes in the literature reviewed here.

### 1.5 A short history of mineral carbonation development work until 2005

Although this report will primarily review the open literature on mineral carbonation for long-term storage of CO<sub>2</sub> published during the three years 2005–2007, a brief re-wrap of the most important results and achievements until 2005 is given in this section.

---

<sup>6</sup> For locations of magnesium-based mineral resources around the world see *e.g.* [122†].

1990–2000: Mineral carbonation was first mentioned as a CO<sub>2</sub> binding concept by Seifritz in 1990 [26†]. A few years later the concept of binding CO<sub>2</sub> in calcium and magnesium carbonate minerals was further investigated in the U.S. by Dunsmore [27†] and subsequently this process, also known as enhanced natural weathering, was investigated in more detail by Lackner and co-workers at Los Alamos National Laboratory (LANL) [1†,4†]. Natural silicate minerals such as olivine, serpentine and wollastonite as well as basalt rock were identified as the most suitable raw materials, being abundant and cheap. Since then, research around mineral carbonation has accelerated and divided into several different CO<sub>2</sub> binding approaches, mainly direct (where the carbonation of the mineral takes place in a single process step) and indirect (where calcium or magnesium is first extracted from the mineral and subsequently carbonated) methods. These primarily aim at *ex situ* processing in a dedicated processing plant (as opposed to *in situ* carbonation by injection of CO<sub>2</sub> into geological formations).

Findings on both direct gas-solid carbonation using pressurised CO<sub>2</sub>, (reaching 25% conversion of 100 µm serpentine particles at 340 bars, 500 °C after 2 h), as well as an aqueous process via chloride salts (after decomposing mineral in hydrochloric acid) were reported by Lackner *et al.* [1†,28†-30†]. For indirect processing, Butt *et al.* [31†] reported a detailed kinetic study on the carbonation of MgO/Mg(OH)<sub>2</sub>. Outside the U.S., Kojima and co-workers [32†] studied the aqueous carbonation of wollastonite in a continuously stirred tank reactor exposed to CO<sub>2</sub> under ambient conditions and found the conversion to be far too slow for an industrial application. A technology assessment that addressed seven processing routes was published by IEA GHG in 2000 [33†], concluding that all suffered from high costs and excessive energy use. At this point it was clear that indirect process routes gave the benefit of much faster carbonation chemistry.

2000 – 2004: In 2000, work on mineral carbonation in Finland was initiated, with carbonation at elevated temperatures (gas phase) as the central feature since this offers the possibility of covering the process energy requirements with the heat from the carbonation reaction [34†,35]. The chemical kinetics of gas/solid carbonation are, however, considerably slower [31†,36†,37] than for carbonation using a direct aqueous process as developed at Albany Research Center (ARC) in the U.S., using a solution of 0.64 M NaHCO<sub>3</sub> and 1 M NaCl in water at 150 bar, 185 °C (for olivine) or 155 °C (for heat treated serpentine), respectively, or wollastonite in water at 40 bar, 200 °C [22,38†,39]. This is currently considered to be the most successful route for serpentine carbonation [6, chapter 7]. The state-of-the-art was wrapped up by Lackner [18†,29†], while Herzog [40†] gave a critical assessment on the method. A second detailed study on the carbonation of MgO/Mg(OH)<sub>2</sub> was made by Béarat *et al.* [41†].

Various pre-treatment methods (chemical, mechanical, thermal) were developed for direct aqueous process routes, which slowly but surely evolved towards staged, *i.e.* indirect processes [42†-44†]. An example of such a route is the process suggested by Kakizawa *et al.* in Japan, which implies dissolving a calcium carbonate in acetic acid, followed by carbonation of calcium acetate (and recovery of acidic acid) [45†].

Since 2000, the carbonation of industrial wastes and by-products such as steel slag, waste cement/concrete and ashes, which often contain significant amounts of calcium that can be carbonated, has also received growing attention. In the Netherlands, Huijgen and Comans initiated experimental work on direct carbonation of wollastonite and steel slags using aqueous solutions; in Finland Teir *et al.* embarked on a study aiming at production of precipitated calcium carbonate (PCC) using the indirect process suggested by Kakizawa; in Japan the carbonation of waste cement/concrete became a research topic [46†]. In the U.S. and Canada carbonation of waste materials and industrial by-products also received attention. All these processes use systems based on aqueous solutions.

In the meantime in Switzerland, Mazzotti and Hänchen and co-workers embarked on studies on Mg-based mineral carbonation and Lackner initiated work on carbonation by trapping CO<sub>2</sub> immediately from air [47†,48†]. In countries such as Lithuania, South Korea, Italy, Norway, Estonia, and Greece work on carbonation for CO<sub>2</sub> fixation has also started. The work on (indirect) carbonation of serpentine using a high temperature, high pressure gas-phase carbonation step only continued in Finland.

## **1.6 Mineral carbonation - current state of the art**

The diagram below, based on but later modified after the previous literature review update [3], displays the various carbonation routes that are currently being investigated. The principal differences to the overview figure given in [3] are, (1) that the two and the three-step aqueous reaction routes have been placed under indirect carbonation alternatives, (2) that the “molten salt” and “three-step NaOH” process routes have been removed and (3) that an additional level “other CO<sub>2</sub> routes” has been added, together with “other solvents” and “multi step gas phase” alternatives under indirect carbonation routes. (“Molten salt” and “three-step NaOH” routes are not discussed in this report as no literature published in 2005-2007 was available to the authors, noting that these routes were considered unattractive already in the previous literature reviews.)



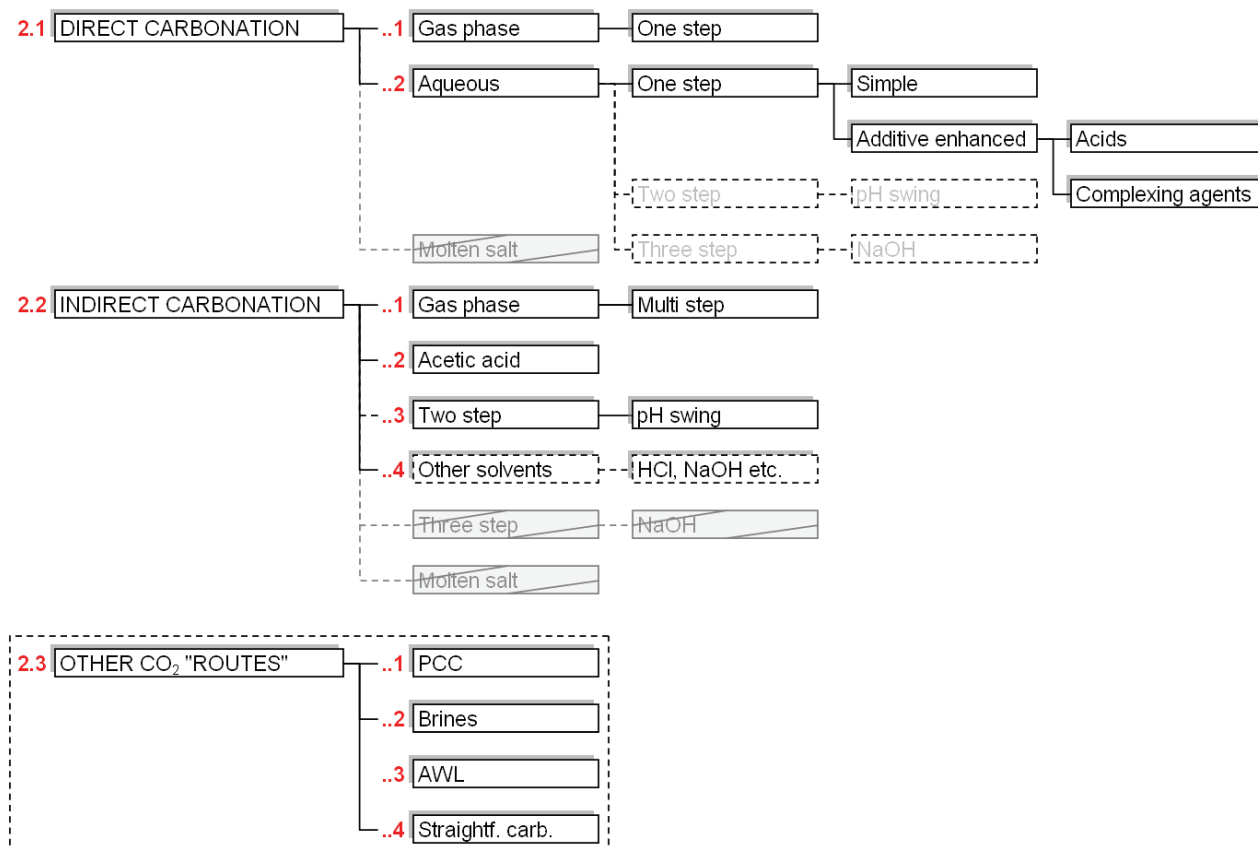

Figure 1.3. Main carbonation processes and variants, modified/updated after Huijgen and Comans [3]. Dotted lines indicate changes with respect to the previous schematic [3]; dotted process route boxes have been moved and grey boxes represent abandoned routes. The numbers prior to some boxes are linked to the heading numbers in this review report.

In addition to the carbonation routes listed under direct and indirect carbonation routes, there are also other carbonation routes such as those using brines<sup>7</sup> as cation (*e.g.* Mg<sup>2+</sup>, Ca<sup>2+</sup>) source. These routes will also be discussed briefly in this review, although the principal focus will be on the same carbonation routes as reviewed in the previous literature review by Huijgen and Comans [3].

<sup>7</sup> A solution with high salinity.

## 2 Process routes for mineral carbonation

Binding carbon dioxide in carbonates can be achieved through various process routes as described in this chapter, ranging from the most basic accelerated weathering of limestone to advanced multi-step processes. Many of the process routes suggested to date have already been abandoned (see [33†]), but research especially around aqueous mineral carbonation has continued (*e.g.* [22,49-52]).

The following sections are intended to contain the recent developments and results achieved in the art of mineral carbonation. Each main heading (*e.g.* 2.1 Direct carbonation) is divided into several sub-headings and each sub-heading (*e.g.* 2.1.1 Direct gas-solid carbonation) is further divided (whenever literature was found) into carbonation processes using naturally occurring minerals and processes using solid process residues as feedstock.

### 2.1 Direct carbonation

Direct carbonation is the simplest approach to mineral carbonation and the principal approach is that a suitable feedstock, *e.g.* serpentine or a Ca/Mg rich solid residue is carbonated in a single process step. For an aqueous process this means that both the extraction of metals from the feedstock and the subsequent reaction with the dissolved carbon dioxide to form carbonates takes place in the same reactor.

#### 2.1.1 Direct gas-solid carbonation

Gas-solid carbonation is an even more simple approach towards mineral carbonation than direct aqueous mineral carbonation. Here particulate metal oxides are brought into contact with gaseous CO<sub>2</sub> at a particular temperature and pressure (for various temperature and pressure ranges applied, see Figure 2.1, p. 23). The dry process has the potential of producing high temperature steam or electricity while converting CO<sub>2</sub> into carbonates. Process integration with mining activities may be very advantageous from an economic point of view of the cost and energy, possibly allowing for, *e.g.*, higher valuable metal extraction rates as well [53†].

Unfortunately, the reaction rates of such a process have been too slow and the process suffers from thermodynamic limitations [34†] and further studies around this alternative have mostly been abandoned. In the previous literature review, Huijgen and Comans [3] concluded that the direct gas-solid carbonation route appears not to have the potential of becoming an industrially viable process.

However, investigation around gas-solid carbonation has not been completely abandoned [23,54] and recent developments suggest that there are still significant improvements to be made in this area, especially considering indirect/multi-step gas-solid carbonation routes [15,35,37,55]. These are discussed in Section 2.2.1.

**Gas-solid carbonation of minerals.** Little research on the direct gas-solid carbonation of mineral materials has been reported since 2004, partly because research at Helsinki University of Technology (TKK) has shifted direction to mainly wet processes for calcium-based material carbonation [56-59]. Research on primarily indirect gas-solid mineral carbonation continues in Finland at Åbo Akademi University at Turku [35,60].

**Gas-solid carbonation of solid residues.** One of the important benefits of using industrial solid residues as feedstock for carbonation compared to the carbonation of mineral ores is the possibility of utilizing a waste stream. The possibility of simultaneously binding CO<sub>2</sub> and lowering the hazardous nature of *e.g.* municipal solid waste incinerator (MSWI) ash makes this carbonation route interesting [54]. However, the potential CO<sub>2</sub> storage capacity for this option is limited, simply because the amounts of material that may be carbonated are too small [19,54].

For example, according to carbonation results obtained by Rendek *et al.* [54] the carbonation potential of all MSWI ash in France (~3 Mt/yr dry matter), would be around 73 kt of CO<sub>2</sub> equivalent per year, which, compared to the total CO<sub>2</sub> emissions of France (375 Mt), is very little. Rendek *et al.* [54] performed their accelerated carbonation experiments in a high pressure vessel at room temperature. The pressure improved the kinetics of the reaction but did not affect the final amount of carbonates formed. Complete carbonation was achieved in 3 h and 30 min at 17 bar CO<sub>2</sub> (highest pressure used) and the carbonation potential was found dependent of the Ca/Si content: a low Ca/Si content resulted in low carbonation potential [61]. The amount of glass in the MSW feed could therefore act as a good indicator of carbonation potential [61]. Still, whether or not this simple process suggested by Rendek *et al.* can be applied on any larger scale remains uncertain<sup>8</sup>, as issues/problems related to scale-up were not discussed.

Another type of industrial solid residues that could be used for CO<sub>2</sub> sequestration is air pollution control (APC) equipment residue, an alkaline residue that can be collected from various incinerator plant flue gas clean-up systems. Around 1,260 kt/yr of APC residue is being produced in the EU, which corresponds to a CO<sub>2</sub> storage potential of about 150 kt/yr (120 g of CO<sub>2</sub>/kg of residue) according to a study by Baciocchi *et al.* [23]. The conclusion of the study was that carbonation of APC is a viable process for CO<sub>2</sub> storage even though, again, it has limited volume potential. The experiments were conducted in a pure CO<sub>2</sub> environment at elevated temperatures (200–500 °C) for 6 h and energy and cost related issues were not considered in that particular study.

In a more recent publication, however, Baciocchi *et al.* [62] investigated the kinetics of gas-solid carbonation of APC residues when subjected to a flux of CO<sub>2</sub> (10 vol-%) in argon. The obtained

---

<sup>8</sup> The relatively slow kinetics of the suggested carbonation scheme would require large high pressure vessels for sufficient carbonation and stabilization of the bottom ash.

kinetic constants ( $1.1 \times 10^{-3}$  and  $1.16 \times 10^{-2}$   $\text{cm}^4/(\text{mol}\cdot\text{s})$  for 300 and 500 °C respectively) resulted in an activation energy of 44.1 kJ/mol, indicating that the process is rapid enough to allow for its implementation (e.g. by direct treatment of flue gases in an fluidized bed). The kinetic analysis was, however, limited to the first stage of the carbonation process. To be precise, it did not take into account the second stage data associated with  $\text{CO}_2$  diffusion through a product layer.

**Direct gas-solid carbonation route conclusions.** Similar to the conclusions in a mineral carbonation route review by Huijgen based on ECN reports [2†] and [3] it can be concluded that direct gas-solid carbonation of minerals remains unviable for industrial purposes and research has moved on to investigate indirect or multi-step gas-solid carbonation options.

### 2.1.2 Direct aqueous carbonation

The direct aqueous mineral carbonation-route<sup>9</sup>, *i.e.* carbonation preformed in a single step in an aqueous solution, appears to be the most promising  $\text{CO}_2$  mineralization alternative to date [19,63†]. High carbonation degrees and acceptable rates have been achieved but the process is (still) too expensive to be applied on a larger scale [3]. Ranging from 40–80 €/t $\text{CO}_2$  mineralized (includes energy use) compared to 0.4–6 €/t $\text{CO}_2$  [6] stored for geological storage (see also Table 2.6). Expensive pre-treatment steps aiming at accelerating the reaction rates must be improved or bypassed in order for this process route to become competitive with other CCS technologies.

Direct aqueous mineral carbonation can be further divided into two subcategories as seen in Figure 1.3 (two-step and three-step alternatives are considered under indirect carbonation routes, in section 2.2), depending on the type of solution used. Studies focusing on carbonation in pure aqueous solutions have quickly made way for additive-enhanced carbonation experiments and a common solution type used today, originally presented by O'Connor *et al.* (2000) [38†], consists of 0.64 M  $\text{NaHCO}_3$  + 1.00 M  $\text{NaCl}$ . Recently, however, it has been reported [64] that there are still improvements to be made regarding the above mentioned solution (see **Additive-enhanced direct aqueous carbonation of minerals** below).

When it is necessary to use additives in carbonation processes it is extremely important to recycle these, due to the large scale of any industrial application [3]. Although many experiments (e.g. [65]) are still being conducted without further considerations towards additive recovery, others [66] have tried to implement recycling of spent additive (e.g.  $\text{NH}_4\text{Cl}$ ) but without major breakthroughs.

---

<sup>9</sup> Huijgen *et al.* [3] divided the direct aqueous carbonation process into three routes (see Figure 1.3): one step, two-step (pH swing) and three-step ( $\text{NaOH}$ ).

Direct aqueous carbonation could also be seen to comprise *in situ* carbonation and several studies have been conducted bearing this in mind. These have been discussed in a separate section below.

***In situ carbonation.*** Studies aiming to deepen the general understanding of mineral carbonation reactions could also be mentioned under direct aqueous carbonation of minerals. For example, McKelvy *et al.* [67] (see also [68] and [69]) have started investigating *in situ* carbonation conditions with two novel reaction systems that enables them to control and vary a wide variety of process conditions such as those associated with *in situ* or above ground mineral carbonation. Hansen *et al.* [70] have also studied *in situ* mineral reactions, especially those associated with listwanite (carbonated serpentinite) formation. They found that minimising porosity loss and maximising permeability is beneficial for carbonation. This could be achieved using a CO<sub>2</sub>-rich aqueous fluid, *i.e.* by controlling the input gas composition. Other studies providing tools for improving mineral carbonation have been provided by Hänchen *et al.* [52,71-73] who have investigated and provided models for both olivine dissolution and precipitation.

Yajima *et al.* [74] studied the reactions of serpentinite (L/S = 50 kg/kg) when subjected to a 10 bar CO<sub>2</sub>-pressure for 8 days at 50 °C, after this the solution containing dissolved elements was removed and mixed with a fresh serpentinite sample in a CO<sub>2</sub> free environment for 14 days. The experiments resulted in a carbonate/initial rock sample (PSD 0.1–0.5 mm) ratio of 1.7–10%-vol in the form of FeCO<sub>3</sub> with some 25% magnesium. Converting this to rate of CO<sub>2</sub> fixation gives: 1.4–5.4×10<sup>-9</sup> mol-CO<sub>2</sub>/(cm<sup>2</sup>·day), *i.e.* it “may be possible” to sequester CO<sub>2</sub> in serpentinite rock [74].

***Direct aqueous carbonation of minerals*** has recently been studied by Munz *et al.* [39] who concluded, based on the fluid phase only, that the reaction rates achieved<sup>10</sup> (5×10<sup>-13</sup>–9×10<sup>-11</sup> mol/(cm<sup>2</sup>·s) are sufficient for industrial application. The experiments were performed by mixing 75–200 µm olivine (~90% pure) particles with H<sub>2</sub>O and CO<sub>2</sub> at 80–250 °C and 100–180 bar. Further experiments are being conducted in order to verify the results based on the precipitated solids as well.

Another study, implementing direct aqueous carbonation, was recently conducted by Domingo *et al.* [75] emphasizing the importance of controlling mechanisms of the carbonation reaction in order to obtain a calcium carbonate product with the desired properties (*e.g.* average particle size, PSD, morphology and specific surface area). Although not directly related to the reduction of atmospheric CO<sub>2</sub> emissions, nor the carbonation of naturally occurring minerals, the study showed that using high pressure supercritical CO<sub>2</sub> for the carbonation of a Ca(OH)<sub>2</sub><sup>11</sup>-suspension at 318 K, a rhombohedral calcite with a low degree of agglomeration can be obtained. Surprisingly, when the

---

<sup>10</sup> The specific experimental conditions were not given, experiments were performed at 100–180 bar and 80–250 °C for particles of 75-200 µm.

<sup>11</sup> The name of the naturally occurring mineral is portlandite.

reagents concentration was reduced, using liquid or dense vapour phase CO<sub>2</sub>, the degree of agglomeration increased. Domingo *et al.* [75] suggested that this could be partially related to the reduced interface tension between compressible and incompressible phases at supercritical conditions of CO<sub>2</sub>, favouring the formation of highly dispersed CaCO<sub>3</sub> particles (microemulsion). Complete carbonation was achieved in less than 2 h for the vapour (6.6 MPa) and supercritical (20 MPa) CO<sub>2</sub> experiments at 318 K, but not so at the other temperature studied, 298 K. Stirring speed also accelerated the carbonation reaction by removing amorphous CaCO<sub>3</sub> product material from the surface of the slaked lime particles.

**Direct aqueous carbonation of solid residues** is a natural process taking place when, *e.g.* waste incinerator ashes are piled in heaps at a waste disposal site and it begins to rain (or a snow cover starts to melt). Speeding up this simple reaction has been investigated by, for instance Back *et al.* [76], who investigated the CO<sub>2</sub> uptake potential of lignite fly ashes. An experiment performed in 30 °C under atmospheric pressure ( $p_{\text{CO}_2} = 0.1$ ) and a low S/L ratio (1/80) resulted in a maximum CO<sub>2</sub> binding capacity of around 0.1 kg CO<sub>2</sub>/kg ash in 1 h, corresponding to 0.5% of the CO<sub>2</sub> emissions from a brown coal firing plant. Research around this topic is expected to continue as the maximum capacity achievable is as high as 5.5%, based on the assumption that the main content of Ca (38.1% CaO) and Mg (16.4% MgO) in the fly ash could be converted to carbonates.

In general, industrial residues, wastes and by-products react more rapidly than natural minerals, but there are considerable differences in reactivity amongst different residues. Changes in process conditions can greatly affect the characteristics and composition of the residue. For example, as demonstrated in some aqueous carbonation experiments performed (at room temperature and atmospheric pressure in an aqueous solution CaO- or MgO/H<sub>2</sub>O = 0.0052, in contact with a gas mixture of 10% CO<sub>2</sub> and 90% air) by Kuusik *et al.* [24], the carbonation degree of oil shale ash is improved if CFBC (53.1–80.2%) is used instead of PF (51.6–56.1%). However, reaction rates were not mentioned explicitly.

**Additive-enhanced direct aqueous carbonation of minerals.** Research around the rate-limiting factors concerning CO<sub>2</sub> mineralization using aqueous solutions is ongoing at several locations and one of the factors that has received increasing attention is the formation of a passivating silica-rich layer around the mineral particle. In a recent study by Bearat *et al.* [49], the formed layer of carbonate was found to be brittle and readily susceptible to fracture and exfoliation by particle abbreviation. Thus, significantly enhanced carbonation reactivity could be achieved by maximizing particle interaction and mechanical effects (attrition, abrasion). This was also observed by McKelvy *et al.* [64], who improved the extent of olivine carbonation by adding quartz to a stirred reactor. The extent of carbonation achieved its maximum with a 60%-wt quartz addition (*i.e.* 6 g quartz to 4 g olivine). McKelvy *et al.* [64] also noticed that “abraded/used quartz” is much less effective at removing the passivating layer formed around the olivine (magnesium silicate) particles.

Investigating particle interaction is difficult or not possible under the conditions typically used (150 atm, 185 °C for olivine) for direct aqueous carbonation using direct measurements of, for

example, volume fraction distribution or velocity fields [77]. Simulations, on the other hand, can provide valuable information about the interactions taking place inside the reactor. Saha *et al.* [77] created a mathematical model that allowed them to study the influence of particle size distribution (PSD) inside a stirred reactor. They confirmed that other factors, than merely available surface area, affect the outcome of the carbonation process, concluding that different size fractions (<37, 37-75, >75 and <150  $\mu\text{m}$ ) are displaced differently in the reactor and that this could affect the amount of collisions amongst the particles.

The possibility to use larger particles for carbonation processes is tempting as the expenses associated with particle size reduction could be considerably reduced. Bearat *et al.* [49] suggested that larger particles might promote particle-particle interaction, based on their experiments conducted at 185 °C, 135 bar  $\text{CO}_2$  and a stirrer speed of 1,500 rpm with an aqueous solution of 0.64 M  $\text{NaHCO}_3$  + 1.00 M  $\text{NaCl}$ , varying only particle size and reaction time. A similar conclusion, *i.e.* larger particles could be used for better carbonation results, was also given by Penner *et al.* [78], but instead of using a typical autoclave reactor, a flow-loop reactor was used for the experiments. The results of the experiments indicated that a mixture of coarse (75–150  $\mu\text{m}$ ) and ultrafine (< 4  $\mu\text{m}$ ) particles could give improved carbonation reactivity. In the experiments a 53% degree of the carbonation reaction was achieved, instead of the expected 40%. Additional tests and modelling are being planned to understand the mechanisms behind this result [78].

SEM-EDX analysis performed by Huijgen *et al.* [79] showed that the formed carbonate ( $\text{CaCO}_3$ ) is found both at the surface of the wollastonite particle and as separate particles, as was also the case in the experiments performed by Bearat *et al.* [49]. This is of interest considering the separation of the products from the un-reacted feedstock. If the product material is formed as separate phases they should be easier to remove and recycling of the feedstock material would be possible.

A  $\text{SiO}_2$  rich layer gradually forms on the wollastonite (calcium silicate) particle and indicates incongruent<sup>12</sup> leaching between Ca and Si, which effectively slows down the carbonation process and the reaction rate decreases rapidly with time [31†]. However, at higher temperatures (> 200 °C) the reaction rate becomes more affected by the  $\text{CO}_2$  pressure which suggests that the reaction steps involving  $\text{CO}_2$  or (bi)carbonate have become rate limiting [79]. Huijgen *et al.* [79] stated that the optimum temperature for carbonation is, in fact, determined by the  $\text{CO}_2$  pressure. That is to say, due to thermodynamic equilibrium limitations the carbonation rate decreases with decreasing temperature for a given pressure [37,50].

At temperatures below the optimum temperature for a given  $\text{CO}_2$  pressure the reaction rate is probably controlled by the leaching of Ca or Mg as stated previously, while too high temperatures

---

<sup>12</sup> The species in a material (*e.g.* wollastonite) do not dissolve in their stoichiometric amounts.

result in reduced (bi)carbonate activity and thereby a slower overall carbonation. The observation that the overall carbonation reaction can be separated into two distinct phases, *i.e.* leaching of metal ions from the mineral/solid residue source and the following carbonate formation, has been the motivation for exploring indirect carbonation routes (see section 2.2.3).

Previous research has shown that the wet-chemical reaction rates of mineral carbonation are controlled by the dissolution of Mg/Ca from the feedstock and that increasing the surface area might therefore speed up the carbonation process [80†]. The removal of the Mg/Ca depleted layer forming around the particles after the initial release of Mg/Ca ions could also result in faster reactions [21,49,64]. Recently, however, gradually more studies have found that there are other factors involved than merely the area of the exposed surface [81]. To exemplify this, Kleiv and Thornhill [81], compared the specific rate constants of two olivine samples that had been milled for 1 respectively 60 minutes. The rate constant of the sample milled for 60 minutes was nine times higher, while the specific surface area of the sample was only 1.8 times greater than that of the 1 minute sample. The difference (a factor of almost five) was attributed to structural effects.

Determining the dissolution rate of olivine and serpentine in aqueous solutions has been the focus of several studies [73 and refs. within], but due to the varying properties of natural minerals as well as very low aqueous concentrations the results of the studies have been difficult to compare. Hänchen *et al.* [73], however, critically analysed experimental results achieved in earlier studies, while comparing those to their experiments performed at 90, 120 and 150 °C. They were able to describe the dissolution of olivine with a shrinking particle model (estimated experimental error ~15%), which combined with magnesium precipitation studies “could bring important new insights into our understanding of the entire mineral carbonation process” [73].

Later Hänchen *et al.* [71] developed another (based on a population balance approach) model to better describe the dissolution of olivine. It was concluded that the previous model [73] could be used as a good approximation for narrow size distributions, while the improved model is able to handle a much wider range of particle sizes.



**Energy evaluation.** A recent energy-related evaluation of the aqueous carbonation route, was conducted by Huijgen *et al.* [51]. The best process conditions for wollastonite within the investigated range were found for a reactor (L/S ratio 5 kg/kg, stirrer speed 500 rpm) temperature of 200 °C, a CO<sub>2</sub> partial pressure of 20 bar, a reaction time of 15 min and particle sizes smaller than 38 µm resulting in a carbonation degree of 69%. The maximum energetic efficiency ( $\eta_{\text{CO}_2}$ ) for wollastonite was 75% based on Equation (3) and for steel slag, with a carbonation degree of 67%,  $\eta_{\text{CO}_2} = 69\%$ , defined as

$$\eta_{\text{CO}_2} [\%] = \frac{\text{CO}_{2,\text{avoided}}}{\text{CO}_{2,\text{sequestered}}} \times 100 = 100 - \frac{E_{\text{power}} \varepsilon_{\text{power}} + E_{\text{heat}} \varepsilon_{\text{heat}}}{\text{CO}_{2,\text{sequestered}}} \times 100 \quad (3)$$

where  $E_{\text{power}}$  = power consumption of sequestration process (kWh)

$E_{\text{heat}}$  = heat consumption of sequestration process (kWh)

$\varepsilon_{\text{power}}$  = conversion factor for power consumption into CO<sub>2</sub> emissions (kg CO<sub>2</sub>/kWh)

$\varepsilon_{\text{heat}}$  = conversion factor for heat consumption into CO<sub>2</sub> emissions (kg CO<sub>2</sub>/kWh)

Huijgen *et al.* [51] found the most energy-consuming process steps to be grinding ( $\eta_{\text{CO}_2} = -15\%$ ) and CO<sub>2</sub> compression ( $\eta_{\text{CO}_2} = -7\%$ ) and emphasized the need for pilot-scale research on mineral carbonation to support process scale-up. They suggested that improved sequestration efficiencies could be obtained outside the investigated parameter ranges with still smaller particles (particularly for wollastonite) or lowering the CO<sub>2</sub> partial pressure (for steel slag<sup>13</sup>).

The fact that the pre-treatment of the mineral source is energy consuming can be further seen in Table 2.1 as given by O'Connor *et al.* [82†]. Table 2.1 lists the energy requirements of three different grinding alternatives together with an alternative of heat treatment. As can be seen, the energy demand increases steeply as particle size is reduced. The high energy requirements<sup>14</sup> of heat pre-treatment (applied only to serpentine) should also be noticed. The initial crushing and beneficiation step (*e.g.*, gravity separation where required) consumes only marginal amounts of energy compared to other pre-treatment alternatives, *e.g.* stage 2 grinding.

---

<sup>13</sup> In addition, a somewhat longer reaction time could be beneficial for steel slag as the energetic efficiency increased to 73% in 30 min, compared to 69% in 15 min.

<sup>14</sup> Refer to the Appendix (p.48–52) for a discussion on assumptions regarding the contents of Table 2.1.

Table 2.1. Energy consumption of different pre-treatment alternatives for various minerals [22,82†].

Feed material		Pre-treatment energy consumption, kW·h/ton						
		Crush.	Bene.	Grinding			Heat treat.	Total
pretreatment methodology	Stage 1			Stage 2	Stage 3			
Olivine, 100%	Ball mill ( $\approx 75 \mu\text{m}$ )	2		11				13
	Ball mill ( $\approx 38 \mu\text{m}$ )	2		11	70			83
	SMD mill	2		11	70	150		233
Lizardite <sup>a</sup> , 100%	Ball mill ( $\approx 75 \mu\text{m}$ )	2		11				13
	Heat treatment <sup>b</sup> ( $\approx 75 \mu\text{m}$ )	2		11			326	339
Olivine, 70%	Ball mill ( $\approx 75 \mu\text{m}$ )	2	2	15				19
	Ball mill ( $\approx 38 \mu\text{m}$ )	2	2	15	70			89
	SMD mill	2	2	15	70	150		239
Antagorite, 100%	Ball mill ( $\approx 75 \mu\text{m}$ )	2		11				13
	Heat treatment ( $\approx 75 \mu\text{m}$ )	2		11			293	306
	Heat treatment ( $\approx 38 \mu\text{m}$ )	2		11	70		293	376
Wollastonite, 50%	Ball mill ( $\approx 38 \mu\text{m}$ )	2	4	21	70			97
	SMD mill	2	4	21	70	70		167

<sup>a</sup> A serpentine, <sup>b</sup> 630 °C

O'Connor *et al.* [82†] concluded that the increased reaction rates achieved with Stirred Media Detritor® (SMD) mills and heat pre-treatment cannot fully compensate for the associated high energy costs (except for wollastonite). However, it should be noted that O'Connor *et al.* [82†] did not differentiate between CO<sub>2</sub> emissions associated with heat or power generation (as can be seen from Table 2.1). CO<sub>2</sub> emissions caused by the sequestration process have been derived from the assumption that a coal plant, which provides the necessary power, has an overall efficiency of 35%. This assumption adversely affects the results of the calculations. Correcting for this, following Equation (3) [51] would significantly reduce the sequestration costs calculated by O'Connor *et al.* [82] for heat treated serpentine.

A separate section has been added here as an Appendix, comparing the original mineral carbonation energy evaluation results by O'Connor *et al.* [82†] re-calculated similar to (but more general than) the approach given by Huijgen *et al.* [51].

**Optimising direct aqueous carbonation.** Considering the non-complete conversion of the minerals, the mineral amounts required significantly exceed the theoretical amount. Gerdemann *et al.* [22] estimated that it would require 6.5–8.9 tons of serpentine or around 8.9 tons of wollastonite for every ton of CO<sub>2</sub> sequestered (compared to the theoretical amount of 2.1 and 2.6 ton mineral/ton CO<sub>2</sub>). Therefore it is very important to consider the environmental (and economic) impact of the necessary mining operations related to *ex situ* CO<sub>2</sub> sequestration [22], including product material disposal/utilization.

Depending on the type of feedstock used for the carbonation process, different process conditions should be applied. Table 2.2 gives the optimal carbonation conditions, by Albany Research Center

(ARC), for olivine, wollastonite and heat treated (HT) serpentine together with the extent of carbonation under these conditions after 1 h.

Table 2.2. Optimum carbonation conditions and extent of carbonation after 1 h [22,82†].

Mineral	T (°C)	P <sub>CO<sub>2</sub></sub> (atm)	Carrier solution	Carbonation, 1 h (%)
olivine	185	150	0.64 M NaHCO <sub>3</sub> , 1 M NaCl	49.5
wollastonite	100	40	distilled water	81.8
HT serpentine	155	115	0.64 M NaHCO <sub>3</sub> , 1 M NaCl	73.5

The carrier solution consisting of 0.64 M NaHCO<sub>3</sub> and 1 M NaCl is actually the maximum solubility of these two compounds in water at ambient conditions. By increasing the temperature and/or pressure still higher concentrations could be achieved, but this was considered to lead to excessive losses of salts to solids when investigated at ARC [83]. That the addition of NaHCO<sub>3</sub> is beneficial to the carbonation process can be explained by the fact that it increases the carbonic-ion concentration, which in turn lowers the, *e.g.*, magnesium ion concentration required to precipitate magnesite (MgCO<sub>3</sub>). NaCl or Na<sup>+</sup> and Cl<sup>-</sup>, on the other hand, reduce the activity of other ions, thereby increasing the solubility of, *e.g.*, magnesium silicates. Note that it also simultaneously reduces the magnesium carbonate solubility and its use should be optimized taking this into account. [50]

Although the carrier solution developed at ARC [80†], consisting of 0.64 M NaHCO<sub>3</sub> and 1 M NaCl has been a common solution used in aqueous carbonation processes, recent developments suggest that the reaction rates can still be significantly improved by further increasing the bicarbonate (NaHCO<sub>3</sub>, KHCO<sub>3</sub>) concentration. In experiments performed by McKelvy *et al.* [64,84], the final degree of carbonation was almost doubled, compared to the standard ARC solution, when a solution containing 5.5 M KHCO<sub>3</sub> was used under the same reaction conditions (1 h, 185 °C, 150 bar CO<sub>2</sub>, < 38 μm olivine and 1500 rpm).

Clearly there are multiple factors (temperature, pressure, liquid to solid (L/S) ratio, stirring speed, additives, material, PSD etc.) affecting the outcome of (aqueous) mineral carbonation and indeed several studies [49,50,79,85] emphasize the importance of understanding these. One of these studies was conducted by Chen *et al.* [50], who, with the help of basic thermodynamic analysis, explained some of the key parameters affecting the carbonation process by analysing results presented in literature. The process was divided into two principal steps: 1) magnesium ion dissolution and 2) magnesite precipitation and it was concluded that enhancing either one of the two-steps often means limiting the other. Therefore, in order to improve the overall carbonation process, finding a balance between these two steps is essential [50,73].

Hänchen *et al.* [52,71-73] have also extensively studied the chemistry of aqueous mineral (especially magnesium) carbonation. They have provided a model for the dissolution of olivine in

water [71] as well as better understanding of the complex system that is magnesium carbonate precipitation [52].

By investigating olivine precipitation from an  $\text{H}_2\text{O}-\text{CO}_2-\text{Na}_2\text{CO}_3-\text{MgCl}_2$  system at different temperatures and  $\text{CO}_2$  pressures (25 °C and 1 bar, 120 °C and 3 bar, 120 °C and 100 bar), Hänchen *et al.* [52] confirmed that magnesite or hydromagnesite ( $(\text{MgCO}_3)_4 \cdot \text{Mg}(\text{OH})_2 \cdot 4\text{H}_2\text{O}$ ) precipitation during ambient temperatures does not occur, instead nesquehonite ( $\text{MgCO}_3 \cdot 3\text{H}_2\text{O}$ ) precipitation is favoured. At higher temperatures magnesite precipitated and the initial kinetics were determined by supersaturation with respect to brucite (3 bar) and hydromagnesite (100 bar). Only the high temperature and high pressure precipitation experiments were sufficiently rapid for industrial applications, but only if they were supersaturated with respect to hydromagnesite.

Work on finding optimal aqueous carbonation conditions is ongoing and even though it has been studied extensively over the past two years, some questions still remain unanswered. For example increasing the L/S has been reported to have both a positive [79] and a negative effect [20] on  $\text{CO}_2$  conversion. The small (compared to the experimental error) positive effect obtained by Huijgen *et al.* [79], was achieved while increasing the L/S ratio for wollastonite carbonation from 3 to 10 kg/kg<sup>15</sup>. Similarly, a negative effect on  $\text{CO}_2$  conversion was observed when the L/S ratio was increased from 2 (smaller ratios could not be stirred sufficiently) to 20 kg/kg for steel slag in an aqueous solution, which might be attributed to the decreased solubility of calcium due to reduction in the ionic strength of the diluted solution [20].

***Direct aqueous carbonation route conclusions.*** Direct aqueous carbonation has continued to receive attention during the years 2005–2007, but no major breakthroughs have been made during this period of time. However, the advances made to aqueous solution chemistry by McKelvy *et al.* [64] were significant, but again, unless the (expensive) additives used cannot be recycled the process route becomes unattractive. Nevertheless, the studies conducted on direct aqueous carbonation have improved the overall knowledge of aqueous carbonation reactions considerably.

## 2.2 Indirect carbonation

If the process of mineral carbonation is divided into several steps it is classified as indirect carbonation. In other words, indirect carbonation means that the reactive component (usually Mg or Ca) is first extracted from the feedstock (as oxide or hydroxide) in one step and then, in another step, it is reacted with carbon dioxide to form the desired carbonates.

---

<sup>15</sup> It should be noted that Huijgen *et al.* [79] pointed out that: “Based on the limited number of observations with regard to the effect of the L/S ratio, it is uncertain whether the observed slight increase in the conversion is significant”.

## 2.2.1 Multistage gas-solid carbonation route

Direct gas-solid carbonation of silicate minerals has been shown to be too slow for any large scale implementations, but a staged gas-solid carbonation process could overcome the slow reaction kinetics. The process involves extraction of magnesium (oxide or hydroxide) in an atmospheric pressure step followed by a carbonation step at elevated temperature (>500 °C) and pressure (>20 bar). [35]

**Multistage gas-solid carbonation of minerals.** It has been found that the carbonation of MgO is significantly slower than the carbonation of Mg(OH)<sub>2</sub> [31†]. Using this observation Zevenhoven *et al.* [35,36†] suggested (noting that Mg(OH)<sub>2</sub> production from serpentine in one step cannot be done because of thermodynamic limitations) that the direct gas-solid carbonation process should be divided into three-steps; 1) MgO production (Equation 4) in an atmospheric reactor followed by 2) MgO hydration (Equation 5) and 3) carbonation (Equation 6) at elevated pressures according to the following reactions:

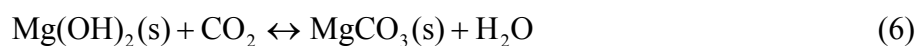

In addition to the faster carbonation kinetics in the three-step gas-solid carbonation route described above, the process is also preferable from an energy efficiency point of view compared to the two-step carbonation of MgO [35]. However, the three-step process is still too slow for large scale implementation, as preliminary tests performed at Helsinki University of Technology (TKK), Finland, in up to 45 bar pressures have shown (see Figure 2.1) [37].

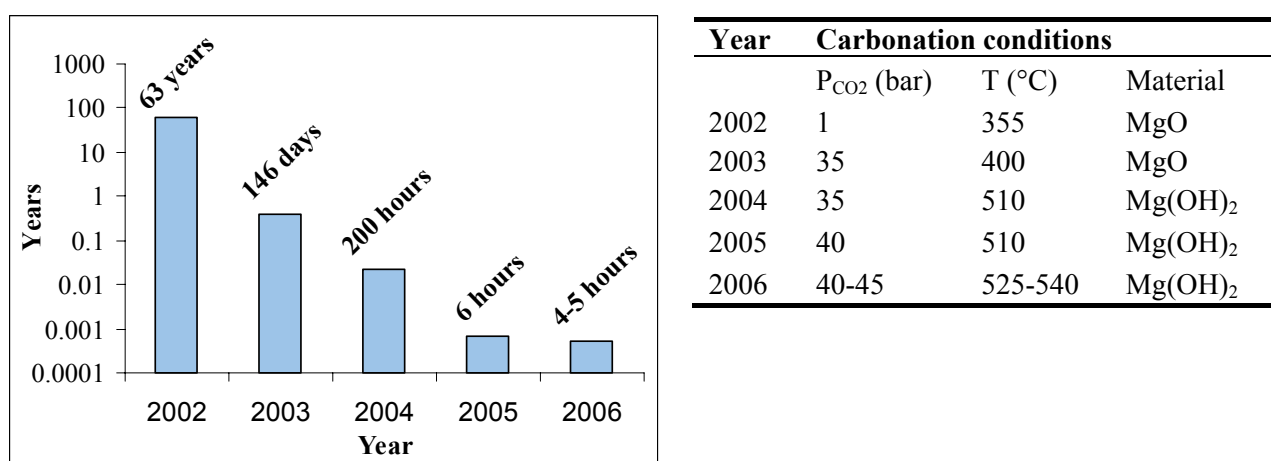

Figure 2.1. Direct gas-solid reaction times achieved for complete carbonation (kinetic control) at various carbonation conditions of 74–125 μm particles at TKK, Finland.

Summarising the results from TKK, as in Figure 2.1, indicate that progress has been made in enhancing the direct gas-solid reaction rates, primarily by increasing pressure. Current work focuses

on experiments in fluidized bed reactors and preliminary tests have shown that product/carbonate removal is possible due to particle collisions (attrition, abrasion) and the following weight reduction, allowing the flue gas to carry the particles out of the reactor. Particle collisions are also beneficial for increasing the overall carbonation reaction rate as product layer diffusion has been shown to become rate limiting after some 5% carbonation [37]. It should however be pointed out that the experimental results in Figure 2.1 have been achieved using pure (97%)  $\text{Mg}(\text{OH})_2$  and not *e.g.* serpentine. In other words, experiments showing that all three-steps in Equations 4–6 are fast enough for industrial implementation are still required.

***Multistage gas-solid carbonation route conclusions.*** Dividing the gas-solid carbonation route into several steps could be beneficial, but there is not enough evidence yet for industrial viability.

### 2.2.2 Acetic acid route

In order to speed up the aqueous carbonation process, the use of acetic acid for the extraction of calcium from a calcium-rich feedstock has been suggested by Kakizawa *et al.* [45†]. In principal it consists of two-steps as given in Equations 7 and 8 [45†]:



Equation 7 describes the extraction step and Equation 8 the precipitation step. In principal the acetic acid used in the extraction step could be recovered in the following precipitation step.

***Indirect aqueous carbonation of minerals using acetic acid.*** Teir *et al.* [57,86] expanded the idea presented by Kakizawa *et al.* [45†] to precipitated calcium carbonate (PCC) and showed that PCC production via the conventional route will give  $\text{CO}_2$  emissions of the order of 0.21 kg/kg PCC (assuming oil combustion for lime calcination) whereas PCC production via the acetic acid route using wollastonite implies a net fixation of 0.34 kg  $\text{CO}_2$ /kg PCC. [15]. (see also Eloneva *et al.* [60])

Research on the extraction of magnesium (and calcium) for carbonation purposes from alkaline-rich materials, has steadily progressed during the last years, even though the principal problem (*i.e.* acid recycling) still remains largely unsolved. (Almost) Complete recycling of the acid/extraction agent is necessary for a process to become feasible in large scale and that has not yet been demonstrated in a cost and energetically effective way.

***Indirect aqueous carbonation of solid residues using acetic acid.*** Inspired by the concept of binding  $\text{CO}_2$  in calcium extracted from a calcium silicate such as wollastonite using acetic acid [45†], Teir *et al.* [56,57] investigated the possibility of producing a high value PCC material from calcium silicates. Later, the concept was developed further in order to find other calcium-containing materials to replace the relatively expensive calcium silicate source of wollastonite [58,87].

Steelmaking slags then became the centre of attention as they can contain significant amounts of both CaO and MgO. Eloneva *et al.* [60] reported that 80–90% pure calcite was produced from blast furnace slag using acetic acid. However, significant amounts of sodium hydroxide were required for promoting the precipitation of carbonates from the acidic solution.

Research in Finland has focused on steel slag carbonation and especially the possibility of producing valuable PCC [58,60,87]. The world steelmaking slag production was estimated to be around 160–200 Mt of iron slag and 96–145 Mt of steel slag in 2003 [58]. Thus, the annual CO<sub>2</sub> binding potential of steelmaking slags is in the order of 70–180 Mt CO<sub>2</sub> assuming similar iron and steel slag compositions (see Table 2.3) as those investigated by Teir *et al.* [58]. Globally the CO<sub>2</sub> sequestration potential for this option is small, but for individual steel plants, however, the method could provide significant economical benefits.

Table 2.3. Composition of various calcium containing materials used by Teir *et al.* [58].

Element	Blast furnace slag (350–500 mm)	Steel converter slag (350–500 mm)	Electric arc furnace slag (125–350 mm)	AOD process slag (<125 mm)	Wollastonite (<250 mm)
CaO	40.6	43.6	40.8	60.7	44.5
SiO <sub>2</sub>	34.1	13.9	26.6	27.6	52.2
Fe <sub>2</sub> O <sub>3</sub>	0.901	24.1	1.59	0.21	0.297
MgO	10.7	1.44	7.21	5.83	0.541
Al <sub>2</sub> O <sub>3</sub>	9.4	1.77	8.36	1.21	1.48
F	0.07	0	0.11	5.5	0.02
Cr	0.003	0.232	5.07	0.228	0.001
Ti	1.03	0.512	2.64	0.356	0.012
Mn	0.376	2.39	2.29	0.076	0.005
S	1.73	0.086	0.092	0.273	0.008

A problem being investigated related to the acetic acid route is that other elements, such as heavy metals, may also leach out during the Ca-extraction phase, leading to impure carbonate precipitate [58]. Research around solvents extracting Ca (or Mg) selectively has therefore been performed [56], as described in the next section. Another problem with this route has been the need for an additive, Na(OH), in order to precipitate carbonates. This additional chemical makes recycling of acetic acid impossible and as a result the chemical costs for this process route are too high for any large scale application.

### 2.2.3 Two-step aqueous carbonation

Two-step aqueous carbonation has been investigated because the overall carbonation reaction can easily be divided into two-steps, *i.e.* extraction and precipitation that may be investigated and optimised separately.

**Two-step aqueous carbonation of solid residues.** By upgrading a waste product into a product of high commercial value, expensive CO<sub>2</sub> sequestration processes could become economically feasible. One such approach has been investigated by Katsuyama *et al.* [88] who studied the use of waste cement for the development of high-purity CaCO<sub>3</sub> by CO<sub>2</sub> carbonisation in accordance with the process scheme in Figure 2.2.

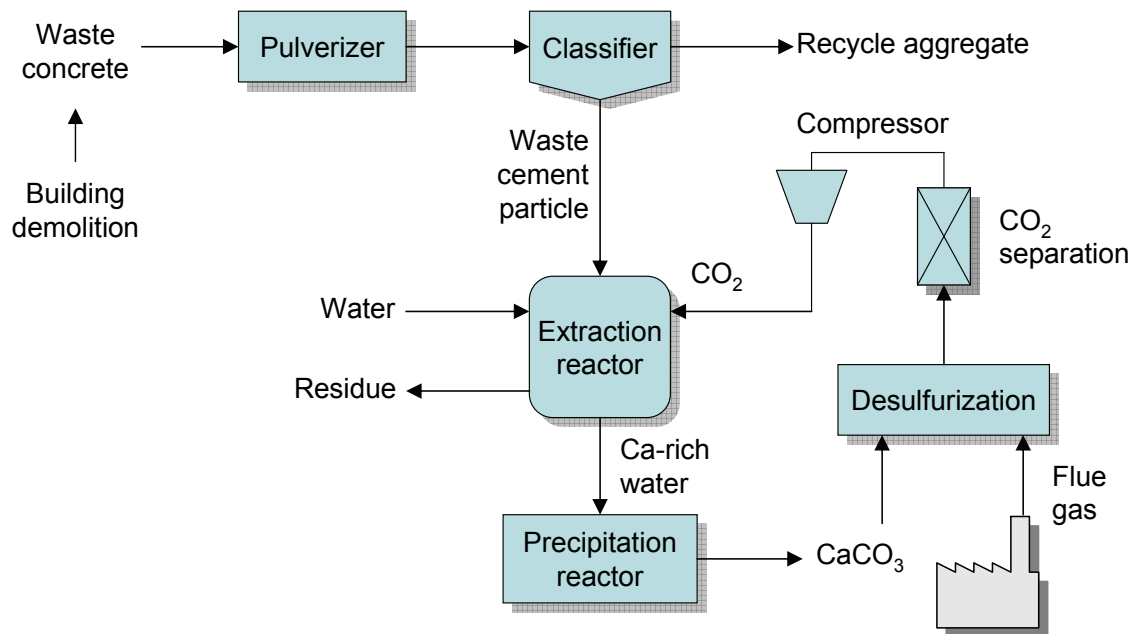

Figure 2.2. Schematic illustration of a CaCO<sub>3</sub> production process from waste cement [88]

Katsuyama *et al.* [88] studied the feasibility of producing CaCO<sub>3</sub> from waste cement by first extracting calcium from pulverized waste cement in a water slurry at high CO<sub>2</sub> pressure (several MPa), followed by the precipitation of CaCO<sub>3</sub> from the extracted solution at lower CO<sub>2</sub> pressures, producing high purity CaCO<sub>3</sub> (up to 98% was achieved) from waste cement at relatively high reaction rates. They estimated that the cost of producing high-purity CaCO<sub>3</sub> could be as low as 136 \$/m<sup>3</sup> (105 €/m<sup>3</sup>) when compared to the commercial price of 200–350 \$/m<sup>3</sup> (154–269 €/m<sup>3</sup>). In addition, if the produced CaCO<sub>3</sub> could be purified to meet the requirements of ultra-high purity CaCO<sub>3</sub> (>99% CaCO<sub>3</sub>) the potential profits could increase substantially. The current cost of ultra-high purity CaCO<sub>3</sub> is around 10,000 \$/m<sup>3</sup> (7,700 €/m<sup>3</sup>), while Katsuyama *et al.* [88] estimated a production cost of only 323 \$/m<sup>3</sup> (250 €/m<sup>3</sup>).

Similar to the process described above, proposed by Katsuyama *et al.* [88], Geerlings *et al.* described a process for producing CaCO<sub>3</sub> from various solid residues in a recently published patent [89]. In the patent, two examples of the described process were given, one utilizing paper bottom ash and one utilizing steel slag. However, the examples do not give a reaction rate for the precipitation step. The extraction of calcium took place inside a water filled stirred reactor for 15 minutes, which resulted in a concentration of 1.1 g of calcium hydroxide per litre for paper bottom ash and 0.46 g/l for steel slag. The formed hydroxide slurry was separated from the solids and carbonated by injecting it with 25 ml CO<sub>2</sub>/min. However, the feasibility of this process should be



investigated by a cost and environmental assessment before further conclusions can be made, which is also the case for a process described in a patent by Gorset *et al.* [90].

Gorset *et al.* [90], describing a way of producing pure  $MgCO_3$  from olivine, claims that the process consisting of one dissolution step and two precipitation steps (both  $MgCO_3$  and amorphous silica) is rapid enough for large scale implementation (dissolution rates around  $1.5 \times 10^{-12} \text{ mol}/(\text{cm}^2 \cdot \text{s})$ ). The process does not require the use of strong mineral or organic acids even though the dissolution step requires an acidic environment. The required acidity (pH 3–5) is to be achieved using pressurised  $CO_2$  (50–150 bar) and a temperature around 100–170 °C, while the following step consisting of  $MgCO_3$  precipitation, takes place in another reactor with preferably a lower  $CO_2$  pressure (50–80 bar) and a higher temperature (140–250 °C) favouring the precipitation of carbonates. Experimental results showed a high degree of purity, between 99.28 and 99.44%  $MgCO_3$ , of the precipitated carbonate.

**The pH-swing process** developed in Japan (and later also presented in a patent by Yogo *et al.* [91]) is another two-step aqueous carbonation process where at first the pH of the solution is lowered thereby enhancing the extraction of divalent metal ions. In the second step the pH is raised to enhance the precipitation of carbonates. Below, in Figure 2.3, is a schematic picture of a process utilizing pH-swing (taken from [66]).

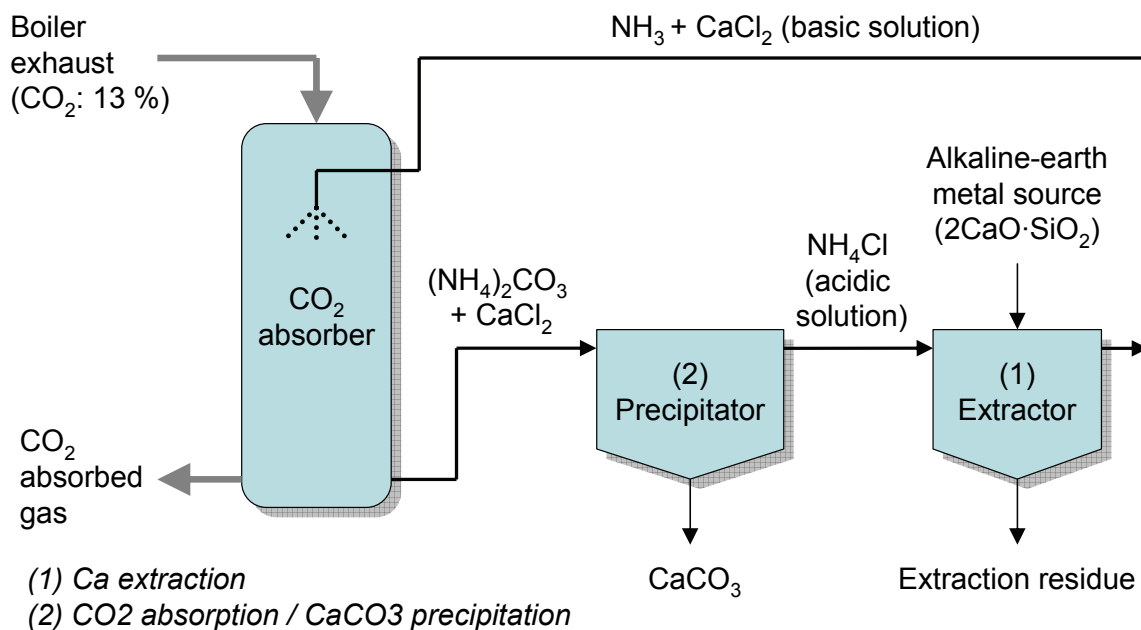
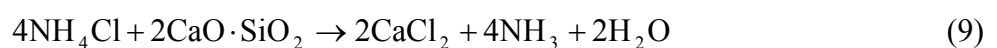

Figure 2.3. Flow diagram of pH-swing process [66].

Figure 2.3 presents a schematic flow diagram of the pH-swing process and the principal reactions taking place inside the extractor (Equation 9) and the precipitator (Equation 10) are:



Equation 10, taking place inside the precipitator, consists of both CO<sub>2</sub> absorption and CaCO<sub>3</sub> precipitation. In their study, Kodama *et al.* [66] investigated a CO<sub>2</sub> sequestration process that utilizes pH swing using NH<sub>4</sub>Cl. The energy input requirement for the investigated process using steel making slag as the mineral source was estimated at around 300 kWh/t CO<sub>2</sub>, but the loss of a chemical additive (NH<sub>3</sub>) was considerable. Investigations on the NH<sub>3</sub> loss problem are ongoing [66].

**Two-step aqueous carbonation conclusions.** Here different approaches of a two-step aqueous carbonation process have been presented. All options are good in theory, but it remains uncertain whether or not these processes could lead the way to any significant scale long-term storage of CO<sub>2</sub> in the future. More experiments (evidence) for large scale viability is required.

#### 2.2.4 Indirect aqueous carbonation - Other leaching enhancing additives

Recently Teir *et al.* [56,59,92] explored the possibilities of extracting magnesium from Finnish serpentinite tailings (from nickel ore mining) for carbonation purposes. Various acids and bases were tested (HCl, H<sub>2</sub>SO<sub>4</sub>, HNO<sub>3</sub>, HCOOH, CH<sub>3</sub>COOH, NaOH, KOH, NH<sub>3</sub>, NH<sub>4</sub>Cl, (NH<sub>4</sub>)<sub>2</sub>SO<sub>4</sub>, and NH<sub>4</sub>NO<sub>3</sub>), but the basic solutions were not effective at extracting magnesium [56]. For the precipitation experiments given in [59], Mg extraction was achieved using solutions of HCl and HNO<sub>3</sub>. The experiments showed that it is possible to produce pure (99%-wt) hydromagnesite from serpentinite, but as discussed above, the loss of acid and the high requirement of NaOH for precipitation makes this process route expensive and therefore unattractive.

In the extraction experiments, sulfuric acid was found to be the best extraction agent of all the chemicals tested, but none of the acids were able to extract Mg selectively. For this selectivity, the ammonium salts tested performed better and no Fe or Si could be measured in the solution after 1 h. However the amount of Mg extracted remained low, only 0.3–0.5%. The effect of the particle size did not influence the Mg extraction rate significantly in the range of 125–500 µm and in 2 h and 70 °C all mineral acids (2 M HCl, H<sub>2</sub>SO<sub>4</sub>, HNO<sub>3</sub>) were able to extract 100% Mg from the serpentinite sample. Product layer diffusion<sup>16</sup> was found to be the rate limiting step for Mg extraction. Data from the extraction/dissolution kinetic analysis performed by Teir *et al.* [56] is listed in Table 2.4.

---

<sup>16</sup> The particle size experiments with large particles did not fully support the theoretical estimations of reaction time, indicating that there are other mechanisms than product layer diffusion at play when larger particles (125–500 µm) are considered.

Table 2.4. Apparent activation energies and frequency factors for the dissolution of serpentinite in various acids [56].

Solvent	Activation energy E (kJ/mol)	Frequency factor $k_0$ (s <sup>-1</sup> )
H <sub>2</sub> SO <sub>4</sub>	68.1±7.3	8.6×10 <sup>6</sup>
HCl	70.4±3.7	1.6×10 <sup>6</sup>
HNO <sub>3</sub>	74.3±5.8	3.4×10 <sup>7</sup>

The effect of H<sub>2</sub>SO<sub>4</sub> on serpentine has also recently been tested by Cheng and Hsu [93], who instead of recovering the extracted magnesium for carbonation, wanted to manufacture high value silica powder. Their experiments showed that significant amounts of Mg (and Fe) can be extracted from serpentine leaving behind mainly SiO<sub>2</sub> using 5 M H<sub>2</sub>SO<sub>4</sub> at temperatures above 80 °C. The significant effect of temperature on, e.g. magnesium extraction can be seen in Table 2.5.

Table 2.5. Chemical composition of raw serpentine before and after treatment in an aqueous sulphuric acid solution (5 M H<sub>2</sub>SO<sub>4</sub>, L/S 10 ml/g) at different temperatures for 48 h. [93]

Composition%	SiO <sub>2</sub>	MgO	Fe <sub>2</sub> O <sub>3</sub>	CaO	Al <sub>2</sub> O <sub>3</sub>
Raw serpentine	40.94	36.14	7.09	1.49	2.5
60 °C	76.22	11.57	1.82	2.12	1.01
80 °C	88.95	2.17	0.65	1.52	0.18
90 °C	90.66	1.07	0.32	1.3	0.04

In a paper by Alexander *et al.* [85] the effects of various reaction parameters (acid concentration, particle size, reaction time and temperature) were investigated in an effort to elucidate the reaction behaviour under milder conditions. Typically elevated temperatures (150 °C), pressures (185 atm) and high acid concentration (HCl, H<sub>2</sub>SO<sub>4</sub>, CH<sub>3</sub>COOH etc.) were used to accelerate the carbonation reaction, but Alexander *et al.* performed their experiments in atmospheric conditions and low temperatures (25–50 °C). The results of the study were in agreement with previous findings (e.g. [44†]) and no significant breakthroughs were given; magnesium extraction improved with increasing acid concentration (1.5–5 M) and decreasing particle size (median size: 163 µm, 125 µm and 63 µm). The reaction times investigated were too short (< 6 h) to play any important part in the experiments. An additional experiment run for 24 h resulted in a 46% improvement of the magnesium extraction compared to a similar experiment run for 6 h. A temperature increase from 25 to 50 °C improved the dissolution rate by 70% when dissolved for 6 h in 2 M H<sub>2</sub>SO<sub>4</sub>.

**Indirect aqueous carbonation using acetic acid (or other solvents) conclusions.** Several studies on mineral carbonation have investigated the possibility of enhancing the overall reaction rate by speeding up the extraction of magnesium or calcium using acetic acid (or some other solvent). However, the problem of effectively recycling the extraction agent remains unsolved and more research is warranted before this route can be considered feasible for long-term CO<sub>2</sub> storage. For PCC production, sufficient PCC quality (purity) should also be demonstrated.

## 2.3 Other processes and CO<sub>2</sub> applications

In addition to the process routes described above, there are other processes and applications that resemble mineral carbonation, but are more suitably described in the following separate section.

### 2.3.1 The production of precipitated calcium carbonate

The production of valuable products (*e.g.* PCC) by utilizing CO<sub>2</sub> has been the objective of many studies in recent years [57,75,88,94] as already mentioned. An example of this concept was given in section 2.2.3, under *Two-step aqueous carbonation of solid residues*. Various methods to obtain a product of desired properties have been used and one of the simplest methods is that of direct aqueous carbonation without the use of additives. More about this option under *Direct aqueous carbonation of minerals* in section 2.1.2.

Direct aqueous carbonation using additives (terpineol 0.1 and 1 vol-%, EDTA 0.25 and 1%-wt) in order to determine their effect on the precipitated calcium carbonate has been studied by Feng *et al.* [94]. Other variables included in the study were CO<sub>2</sub> bubble size (with frit pore size of 17–40 or 101–160 μm), CO<sub>2</sub> gas flow rate (3.5 and 4 l/min), CO<sub>2</sub> concentration (25 and 100 vol-%) and reaction temperature (25 and 80 °C). It appeared that the size of the carbonated particles was slightly smaller with smaller CO<sub>2</sub> bubble size and CO<sub>2</sub> concentration. The effect of the CO<sub>2</sub> gas flow rate and temperature was altered by the addition of additives, but in general the process was quicker at 80 °C than 25 °C. Some of the results disagreed with the literature data reviewed by Feng *et al.* [94], *e.g.* the PCC particle sizes were larger than reported for the additives used. More research is needed to understand the effects of additives.

### 2.3.2 Carbonation using brines

Brine is a saline-based solution that is formed as a waste product during oil or natural gas extraction (over 75 million m<sup>3</sup>/year in the U.S. alone [95†]) and as such it can be found stored in vast quantities in above-ground storage tanks. The large amount and relatively high concentration of metals capable of forming carbonates (mainly Ca and Mg) provides a carbonation process option for carbon dioxide storage. However, despite the fact that brine is capable of forming carbonates, an industrial scale operation is currently limited by slow reaction kinetics. Raising the pH of the brine speeds up the carbonation process, but uncertainties concerning the parameters (brine composition, temperature, pressure and pH) need to be further investigated. [96]

In another recent study, Soong *et al.* [97] investigated the possibility of using fly ash in order to raise the pH of brine, thereby allowing for the precipitation of carbonates from the solution. The results of the experiments proved the feasibility of this concept, and 0.546 mol/l of CO<sub>2</sub> was sequestered in 2 h during a one stage approach via FGD fly ash. The experiments were performed in an autoclave reactor with an initial CO<sub>2</sub> pressure of 1.36 bar at 20 °C. A conceptual model of the

process is given in Figure 2.4 by the solid arrows. The dotted arrows show other alternative brine/ash CO<sub>2</sub> sequestration routes investigated by Soong *et al.* [97]

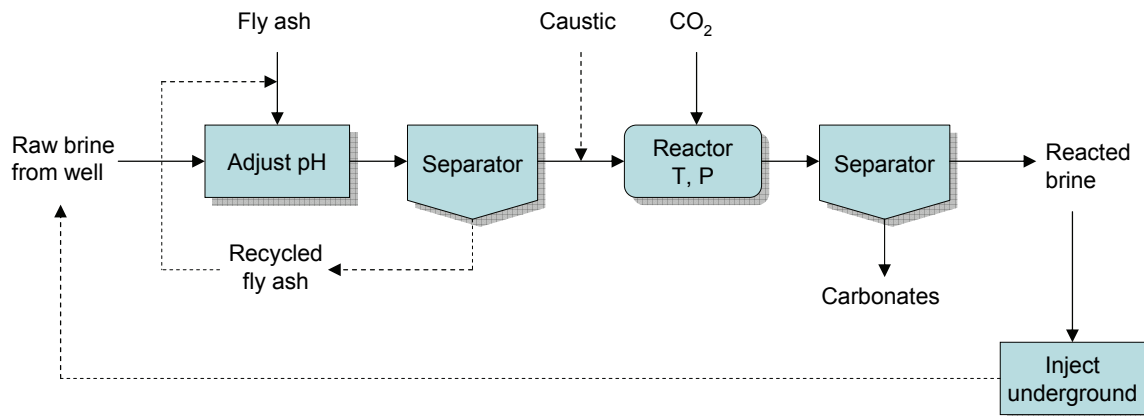
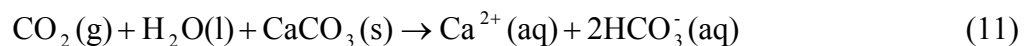

Figure 2.4. CO<sub>2</sub> sequestration process via brine and fly ash [97].

### 2.3.3 Accelerated weathering of limestone

One option that did not receive any attention in the previous literature review [3,19] is carbon dioxide capture and storage by accelerated weathering of limestone (AWL). This option [98†] imitates the natural carbonate weathering according to the following reaction:



The product of an AWL plant would be a calcium bicarbonate solution that could readily be released and diluted into the ocean with a minimal or even a positive environmental impact [99]. However, further research is needed before this alternative can be applied on any larger scale as there are still many issues to deal with, such as the energy demand of transporting large amounts of calcium containing (waste or mineral) material to the AWL plant that preferably should be located near a CO<sub>2</sub> point source as well as a possible disposal site (*e.g.* the ocean). In an ideal case (with access to free limestone, *e.g.* waste fines, and a “free” water source, *e.g.* power plant cooling water) the CO<sub>2</sub> mitigation cost by means of AWL could be as low as 3–4 \$/ton CO<sub>2</sub> (2.3–3.1 €/ton CO<sub>2</sub>). Rau *et al.* [99] suggests that some 10-20% of the United States point-source CO<sub>2</sub>-emissions could be mitigated this way.

In addition, the environmental effects of bicarbonate solution disposal into the ocean were discussed by Rau *et al.* [99]. While direct CO<sub>2</sub> injection into the ocean lowers the pH, releasing a bicarbonate calcium ion containing solution could actually counteract the ongoing ocean pH reduction and in order to avoid negative impacts to the ocean the CO<sub>2</sub> containing flue gas should be free of impurities such as heavy metals. Despite the potential positive effect of bicarbonate disposal Rau *et al.* concludes that further research is needed to fully understand the impacts of AWL effluent disposal in the ocean.

A similar approach to that discussed above is the carbonation of Ca containing waste materials by creating a reaction surface and simply spraying water on it, a simple low-cost approach that might even be applied to larger-scale systems for capturing CO<sub>2</sub> from ambient air in the future [100]. The amounts of CO<sub>2</sub> that could be sequestered are however, using Ca-based materials, not large enough for any further consideration of this option [3], but using naturally occurring magnesium silicates this could be an option [101].

### 2.3.4 Straightforward carbonation

By simply spreading *e.g.* olivine on land where acidity is a problem would simultaneously increase the pH of the soil (*i.e.* improve soil quality) and capture CO<sub>2</sub> from the surrounding air in a relatively short time frame (~30 years). This simple approach to CCS has been suggested by Schuiling and Krijgsman [101] who emphasize that this method, even if simple, should initially be applied with caution so as to confirm the impact of spreading large amounts of rock material on the ground. The amount of CO<sub>2</sub> that could be sequestered in this way is principally limited by available/suitable surface area and the theoretical binding capacity is given by the following reaction [101]:

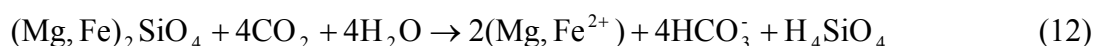

It should be noted that the above reaction is highly dependent on rainfall, soil type, (CO<sub>2</sub> pressure), temperature and type of rock, which limits its applicability.

Another simple approach to CO<sub>2</sub> sequestration is the alternative of carbonation in underground cavities such as caves. Schuiling [102] has discussed the alternative of sequestering CO<sub>2</sub> by filling *e.g.* an opencast mine with olivine containing rock material and injecting CO<sub>2</sub>. The benefits of such a solution are that no expensive reactor equipment would be required and that the reaction kinetics would not be of major importance. In addition, the heat of reaction generated by the reaction between CO<sub>2</sub> (and H<sub>2</sub>O) and olivine could be recovered by placing heat exchangers in the olivine. According to Schuiling this could represent a breakthrough to the solution of the greenhouse problem [102]. It should, however, be noted that unless the kinetics are rapid enough, the system of olivine and CO<sub>2</sub> would reach thermal equilibrium with the surrounding rock material and heat recovery would not be possible.

Significant carbonation can also take place in mine tailings without any intervention (see [103] and refs within), but standard methods have not been suitable to measure the amount of CO<sub>2</sub> trapped within the tailings. Therefore, Wilson *et al.* [103] developed a method that enables the quantification of carbonates in serpentine-rich mine tailings. The estimated error margins were 3% and 15% for carbonate phases in abundances greater than 10%-wt, respectively less than 10%-wt. This method could be used by mine sites with tailings rich in serpentine and provide the mining operation with CO<sub>2</sub> credits.

**Other processes and CO<sub>2</sub> applications conclusions.** Above some of the various applications and processes are listed that could be considered when discussing CO<sub>2</sub> (mineral) storage, but it seems that most of these options are still highly theoretical and lack verification, *i.e.* experimental results. However, all options should be taken into account when considering CO<sub>2</sub> emissions reduction, even though some of these options should not be considered to be “mineral carbonation”.

## 2.4 Pre-treatment options

Increasing the reaction rates of mineral carbonation processes has been and still is a research field that receives attention at several locations. While many studies have focused on modifying the process itself, some studies have looked towards activating the feedstock by various pre-treatment options, including heat, chemical and/or mechanical pre-treatment. One alternative, given by Maroto-Valer *et al.* [104], is combined mechanical and chemical treatment which, when used on raw serpentine, increased the surface area from 8 m<sup>2</sup>/g to over 330 m<sup>2</sup>/g. However, it is uncertain whether this option could balance the loss of chemicals including magnesium (up to 70%) into the solution against the improved reactivity (as already concluded in [3]).

The major problem with many of the pre-treatment options has been (or still is) the high energy input requirement and it was recently concluded that only conventional grinding has been proven to be energetically and potentially economically feasible [3]. This could make serpentine, which would need a heat treatment step<sup>17</sup>, a less suitable starting material despite the huge resources.

Using heat for activating the feedstock has been widely studied (*e.g.*, [80†]) and found to be too energy intensive [83], but in a patent by Geerlings and Wesker [105] it was suggested that hot synthesis gas (*e.g.* formed during coal gasification) should be used as a heat source, since this requires cooling. Typically, hot synthesis gas is available at locations where carbon dioxide is produced. The desired level of heating would be between 600 and 800 °C for serpentine (converts to olivine) and 800 and 1000 °C for talc (converts to enstatite). After the heat treatment the converted material could be carbonated by direct aqueous carbonation, *i.e.* bringing the material in contact with elevated CO<sub>2</sub> pressures (0.1–50 bar) in an aqueous environment [105]. Unfortunately there is no evidence of the process route described in the patent being fast enough for large scale implementation, and naturally its use is somewhat restricted by the requirement of high temperature synthesis gas.

---

<sup>17</sup> Optimum (lowest energy consumption) reaction conditions for the decomposition of Croatian serpentine (<150 µm) have been established at 660 °C and 180 min [117].

## 2.5 Comparing technologies

Some of the literature concerning mineral carbonation published in the past three years (2005–2007) has focused on comparing different alternatives. Here, a summary of the results presented in these studies are given.

There is a considerable difference between various mineral carbonation routes when it comes to costs (see Table 2.7), but there is also a significant difference in mineral carbonation compared to other CCS related costs as can be seen from Table 2.6. Although Table 2.6 is a few years old (2005) the current best case costs for (at least) mineral carbonation appears to remain within the given price range (38–77 €/CO<sub>2</sub> net mineralized).

Table 2.6. Cost ranges for the components of large-scale CCS systems [6] (US\$ have been converted to € according to 1.3 US\$ = 1 €).

CCS system components	Cost range	Remarks
Capture from a coal- or gas- fired power plant	12–58 €/tCO <sub>2</sub> net captured	Net costs of captured CO <sub>2</sub> , compared to the same plant without capture.
Capture from hydrogen and ammonia production or gas processing	4–42 €/tCO <sub>2</sub> net captured	Applies to high-purity sources requiring simple drying and compression.
Capture from other industrial sources	19–88 €/tCO <sub>2</sub> net captured	Range reflects use of a number of different technologies and fuels.
Transportation	0.8–6 €/tCO <sub>2</sub> transported	Per 250 km pipeline or shipping for mass flow rates of 5 (high end) to 40 (low end) MtCO <sub>2</sub> /a.
Geological storage <sup>a</sup>	0.4–6 €/tCO <sub>2</sub> net injected	Excluding potential revenues from EOR or ECBM.
Geological storage: monitoring and verification	0.08–0.2 €/tCO <sub>2</sub> injected	This covers pre-injection, injection, and post-injection monitoring, and depends on the regulatory requirements.
Ocean storage	4–23 €/tCO <sub>2</sub> net injected	Including offshore transportation of 100–500 km, excluding monitoring and verification.
Mineral carbonation.	38–77 €/tCO <sub>2</sub> net mineralized	Range for the best case studied Includes additional energy use for carbonation.

<sup>a</sup> Over the long term, there may be additional costs for remediation and liabilities.

The differences in cost of various CCS related process steps are significant, but mineral carbonation is by far the most expensive one. In Table 2.7, composed by Huijgen *et al.* [106], the costs of different mineral carbonation alternatives have been compared. The estimated costs do not include the cost of mining, CO<sub>2</sub> capture or transport.



Table 2.7. Comparison of sequestration costs (excluding mineral mining, CO<sub>2</sub> capture and transport) for mineral carbonation processes reported in literature [106]. Again, a conversion rate of 1.3 \$ = 1 € has been used where results have been given in dollars (all studies cited here except Huijgen *et al.* [106]).

Costs mineral carbonation (€/ton CO <sub>2</sub> avoided)	Feedstock	Process route	Extraction agent	Reference
86	Wollastonite	Direct	Water	[83]
102	Wollastonite	Direct	Water	[106]
77	Steel slag	Direct	Water	[106]
60	Olivine	Direct	Water <sup>a</sup>	[83]
238	Serpentine <sup>b</sup>	Direct	Water <sup>a</sup>	[83]
88 <sup>c</sup>	Mg-silicate	Direct	Molten MgCl <sub>2</sub>	[33†]
23 <sup>d</sup>	Waste cement	Indirect	Water	[107†]
53 <sup>d</sup>	Wollastonite	Indirect	Acetic acid	[45†]
>138	Mg-silicate	Indirect	HCl	[33†]

<sup>a</sup> Salts added: 0.64 M NaHCO<sub>3</sub>, 1 M NaCl.

<sup>b</sup> Heat-treated.

<sup>c</sup> Assuming make-up MgCl<sub>2</sub> is not produced on-site, but has to be imported.

<sup>d</sup> Comprises only power costs and, in the case of waste cement, a revenue for selling CaCO<sub>3</sub>.

To improve the economics of mineral carbonation, Huijgen *et al.* [106] recommended that particular focus should be placed on the carbonation degree (especially for wollastonite, due to the high ore cost) in pilot scale experiments and the required L/S ratio. Integrating mineral carbonation with CO<sub>2</sub> capture was also recommended, as the price for CO<sub>2</sub> capture by current means is comparatively high (ranges from 12 \$ (9 €) for a new hydrogen plant to 44 \$ (34 €) for a new NGCC plant, IPCC, 2005) [6].

Another approach to CO<sub>2</sub> sequestration by mineral carbonation was taken by Khoo and Tan [108], who applied the Life Cycle Assessment (LCA) on five different process alternatives presented by the ARC team (see Table 2.1) [83]. Table 2.8 summarises the energy requirements for the five processes investigated, but it should be noted that the same assumptions as those by ARC, regarding power and heat consumption of the various alternatives, have been used (affecting especially methods 3 and 4).

Table 2.8. Energy requirements per ton CO<sub>2</sub> for the five processes investigated [108].

#	Mineral source	Tons of mineral required (R <sub>CO2</sub> )	Conversion efficiency (R <sub>x</sub> )	Total energy <sup>b</sup> for standard pretreatment and carbonation (kWh/ton CO <sub>2</sub> )	Total energy <sup>b</sup> for activation: 3 <sup>rd</sup> stage grinding (kWh/ton CO <sub>2</sub> )	Total energy <sup>b</sup> for activation: heat <sup>c</sup> Treatment (kWh/ton CO <sub>2</sub> )
1	Olivine 100%	1.8	0.81	300	333	-
2	Olivine 70%	1.8	0.81	320	333	-
3	Lizardite <sup>a</sup> 100%	2.5	0.4	180	-	2022
4	Antigorite <sup>a</sup> 100%	2.1	0.92	180	-	829 <sup>d</sup>
5	Wollastonite 50%	2.8	0.82	190	239	-

<sup>a</sup> Serpentine

<sup>b</sup> For the sequestration of 1 ton of CO<sub>2</sub>

<sup>c</sup> Heat requirement calculated as power input.

<sup>d</sup> Note that  $(R_{CO_2} \times 293 \text{ kWh/ton CO}_2) / R_x = 669 \text{ kWh/ton CO}_2$  and not 829 kWh/ton CO<sub>2</sub>.

The LCA study presented by Khoo and Tan [108] does not take into account transportation of CO<sub>2</sub> from the power plant, but unlike the results of the cost comparison in Table 2.7, CO<sub>2</sub> capture<sup>18</sup> was taken into consideration. The most promising CCS method consisted of CO<sub>2</sub> capture by chemical absorption and wollastonite carbonation (method 5) followed by chemical absorption and olivine (methods 2 and 3) carbonation. Method 3 was found completely unacceptable, while method 4 might be used for CO<sub>2</sub> sequestration due to the vast amount of serpentine resources. However, the conclusions for methods 3 and 4 (the serpentines) have been made assuming that energy required for heat treatment has been derived directly from power generation and not, for example, by considering already existing (waste) heat streams.

Fundamentally then and similar to the discussion in section 2.1.2 the results given in Table 2.8 do not differentiate between energy required for heat versus electricity generation. Thus, the results suffer from the same problem as discussed in the Appendix.

<sup>18</sup> Chemical absorption (energy required 330–340 kWh/tCO<sub>2</sub>, capture efficiency 95–98%); Membrane separation (70–75, 82–88%); Cryogenics (600–660, 90–95%); Pressure swing adsorption (PSA) (160–180, 85–90%).

### 3 Discussion and conclusions

Since the beginning of 2005, *i.e.* when the previous literature review by Huijgen and Comans [3] was released, a great deal of new information has been made available and progress has been made in the field of mineral carbonation. For example, the multi-stage gas-solid carbonation route has been presented as a new option since 2004, but more research is needed before any significant conclusions can be made concerning its large-scale viability. Previous findings on additive-enhanced carbonation reactions have also been improved and the standard aqueous solution (0.64 M NaHCO<sub>3</sub> and 1 M NaCl) developed at ARC could be replaced by high alkali bicarbonate concentrated (e.g. 5.5M KHCO<sub>3</sub>) solutions. All things considered, the general understanding of magnesium and calcium carbonation reactions has improved significantly (e.g. studies by Hänchen *et al.* [52,71-73]).

Nevertheless, little progress has been made when it comes to the recovery and recycling of additives, which (as concluded already in the previous review [3]) is a key issue for the continued development of mineral carbonation, unless of course the use of additives is by-passed altogether.

In general the additive-free alternatives are not able to match the additive-enhanced methods in reactivity and studies have been conducted to better understand the complex reactions involved in carbonate systems. Although informative, these studies have not yet resulted in any significant breakthroughs in reactivity or mineral carbonation in general.

Many researchers [37,56,79] have attributed the rate limiting step of wet carbonation to product layer diffusion and it has become widely accepted that particle-particle(mechanical) interaction inside the reactor could provide a way to enhance carbonation for both wet [49,64] and dry methods [37], for example by using a fluidized bed. Further research is required to verify these findings.

It has previously been stated that direct aqueous carbonation is the most promising mineral carbonation option presented to date, but cost evaluations<sup>19</sup> of the route have shown that it is still too expensive compared to other CCS methods. It seems, however, in the light of the different studies focusing on either the dissolution step or the subsequent precipitation step that these two-steps should be kept separate. This would remove the need for balancing two opposite reactions (dissolution and precipitation) in a single tank, despite the increased investment (and operational) costs of a more complex reactor system.

---

<sup>19</sup> An additional chapter is given in the appendix comparing previous cost evaluation studies [22,82†] to results presented by Huijgen *et al.* [106]. The comparison shows the clear difference between results achieved by assuming energy in the form of electricity and/or energy in the form of heat.

It currently seems that indirect aqueous carbonation is the most attractive route, while some of the alternatives have already been abandoned (*e.g.* molten salt, see [3]). Other alternatives, such as straightforward carbonation options represent interesting alternatives in certain cases, but require to be supported by experiments.

Much work has also been done around the production of valuable end products, such as high-purity PCC, but none of the suggested options have yet resulted in large scale production. A valuable end product would allow for much higher operational costs for a carbonation plant and possibly lead the way for other mineral carbonation options. For example, Katsuyama *et al.* estimated a production cost of only 323 \$/m<sup>3</sup> (250 €/m<sup>3</sup>) for ultra-high purity CaCO<sub>3</sub> compared to the commercial price of 10,000 \$/m<sup>3</sup> (7,700 €/m<sup>3</sup>) using a new process method presented in [88].

Another aspect of mineral carbonation that has received comparatively little attention to date is the destiny of the CO<sub>2</sub>-containing end product. If mineral carbonation becomes a large-scale CO<sub>2</sub> sequestration alternative, the amount of carbonates produced would be very large and consequently disposal would be problematic. However, mineral carbonation might never become a global scale industry [3].

To finalize this section, one could refer to IPCC's 4th Assessment Report (AR4) "Climate Change 2007" principally based on the Special report on carbon dioxide capture and storage [6]) which states the following: "Industrial fixation through the formation of mineral carbonates requires a large amount of energy and costs are high. Significant technological breakthroughs will be needed before deployment can be considered." [109, chapter 4]. Basically indicating that research around mineral carbonation requires completely new approaches or significant improvements of old ideas/process routes.

Conversely, James Lovelock in his recent "The revenge of Gaia" prefers mineral carbonation as part of our future energy supply system: "...burning fossil fuels under conditions where the carbon dioxide effluent is safely sequestered, preferably in the form of an inert solid, such as magnesium carbonate." [110, p. 137].

## 4 Bibliography

- [1†] Lackner, K.S., Wendt, C.H., Butt, D.P., Joyce, E.L., Sharp, D.H., **1995**, *Carbon dioxide disposal in carbonate minerals*, Energy. (20), pp. 1153-1170.
- [2†] Huijgen, W.J.J., Comans, R.N.J., **2003**, *Carbon dioxide sequestration by mineral carbonation: Literature review*, ECN-C--03-016, Energy Research Centre of the Netherlands.
- [3] Huijgen, W.J.J., Comans, R.N.J., **2005**, *Carbon dioxide sequestration by mineral carbonation: Literature review update 2003-2004*, ECN-C--05-022, Energy Research Centre of The Netherlands, Petten, The Netherlands.
- [4†] Goff, F., Lackner, K.S., **1998**, *Carbon dioxide sequestering using ultramafic rocks*, Environmental Geosciences. (5), pp. 89-101.
- [5] Huesemann, M.H., **2006**, *Can advances in science and technology prevent global warming? Mitigation and Adaption Strategies for Global Change*. (11), pp. 539-577.
- [6] IPCC, **2005**, *IPCC special report on carbon dioxide capture and storage*, Prepared by Working Group III of the Intergovernmental Panel on Climate Change [Metz, B., O. Davidson, H. C. de Coninck, M. Loos, and L. A. Meyer (eds.)], Cambridge University Press, Cambridge, United Kingdom and New York, NY, USA.
- [7] CO2CRC, (**2007**), *CO2CRC image library - diagrams (general)*, The Cooperative Research Centre for Greenhouse Gas Technologies, [http://www.co2crc.com.au/imagelibrary/diagrams\\_g.html](http://www.co2crc.com.au/imagelibrary/diagrams_g.html).
- [8] Armor, J.N., **2007**, *Addressing the CO<sub>2</sub> dilemma*, Catalysis Letters. (114), pp. 115-121.
- [9] House, K.Z., Schrag, D.P., Harvey, C.F., Lackner, K.S., **2007**, *Permanent carbon dioxide storage in deep-sea sediments*, 8<sup>th</sup> International Conference on Greenhouse Gas Control Technologies, 19-22 June, 2007, Trondheim, Norway, paper 01\_013\_01.
- [10] Teir, S., Eloneva, S., Fogelholm, C.-J., Zevenhoven, R., **2006**, *Stability of calcium carbonate and magnesium carbonate in rainwater and nitric acid solutions*, Energy Conversion and Management. (47), pp. 3059-3068.
- [11†] Koljonen, T., Siikavirta, H., Zevenhoven, R., Savolainen, I., **2004**, *CO<sub>2</sub> capture, storage and reuse potential in Finland*, Energy. (29), pp. 1521-1527.
- [12] Lee, J.K., Dong, W.K., **2005**, *Characteristic study of Korean magnesium silicates for CO<sub>2</sub> mineral carbonation*, 22<sup>nd</sup> annual international Pittsburgh coal conference, 12-15 September, Pittsburgh, PA, USA.
- [13] Kavaliauskaite, I., Uibu, M., Teir, S., Kuusik, R., Zevenhoven, R., Denafas, G., **2005**, *Carbon dioxide long-term emissions and its storage options in the Baltic region*, ECOSUD2005/ 5<sup>th</sup> Int. Conf. on Ecosystems and Sustainable Development, May 3-5, 2005, Cadiz, Spain.
- [14] Stasiulaitiene, I., Denafas, G., Sliupa, S., **2007**, *Lithuanian serpentines as potential carbon dioxide binders*, The 32<sup>nd</sup> International Technical Conference on Coal Utilization & Fuel Systems, June 10-15, Clearwater, Florida, Usa, (paper 43).

- [15] Zevenhoven, R., Eloneva, S., Teir, S., **2006**, *Chemical fixation of CO<sub>2</sub> in carbonates: Routes to valuable products and long-term storage*, Catalysis Today. (115), pp. 73-79.
- [16] InfoMine, **2007**, *Mining intelligence & Technology/Mine sites*, <http://www.infomine.com/minesite/minesiteall.asp>.
- [17] Graves, S., Krevor, S., Lackner, K.S., **2006**, *Ultramafic deposits in the United States suitable for mineral carbon sequestration*, 31<sup>st</sup> International Technical Conference on Coal Utilization & Fuel Systems, May 21-26, 2006, Clearwater, Florida, USA, (paper 43), p. 402.
- [18†] Lackner, K.S., **2003**, *A guide to CO<sub>2</sub> sequestration*, Science. (300), pp. 1677-1678.
- [19] Huijgen, W.J.J., Comans, R.N.J., **2007**, *Carbon dioxide sequestration by mineral carbonation: Literature review*, Thesis: Carbon dioxide sequestration by mineral carbonation. , pp. 31-60.
- [20] Huijgen, W.J.J., Witkamp, G.J., Comans, R.N.J., **2005**, *Mineral CO<sub>2</sub> sequestration by steel slag carbonation*, Environ. Sci. Technol. (39), pp. 9676-9682.
- [21] Bertos, F.M., Simons, S.J.R., Hills, C.D., Carey, P.J., **2005**, *Accelerated carbonation of contaminated land and waste residues as a contribution to carbon sequestration*, Fourth Annual Conference on Carbon Capture & Sequestration, May 2-5, Alexandria, Virginia, USA, (Poster).
- [22] Gerdemann, S.J., O'Connor, W.K., Dahlin, D.C., Penner, L.R., Rush, H., **2007**, *Ex situ aqueous mineral carbonation*, Environ. Sci. Technol. (41), pp. 2587-2593.
- [23] Baciocchi, R., Polettini, A., Pomi, R., Prigiobbe, V., VonZedwitz, V.N., Steinfeld, A., **2006**, *CO<sub>2</sub> sequestration by direct gas-solid carbonation of air pollution control (APC) residues*, Energy Fuels. (20), pp. 1933-1940.
- [24] Kuusik, R., Uibu, M., Trikkel, A., **2006**, *CO<sub>2</sub> emission in Estonia oil shale based energy sector – prospects for abatement by wet mineral carbonization*, 8<sup>th</sup> International Conference on Greenhouse Gas Control Technologies, 19-22 June, Trondheim, Norway.
- [25] Uibu, M., Kuusik, R., **2007**, *Concept for CO<sub>2</sub> mineralization by oil-shale waste ash in Estonian power production*, The 3rd International Green Energy Conference, 17-21 June, Västerås, Sweden, IGEC.
- [26†] Seifritz, W., **1990**, *CO<sub>2</sub> disposal by means of silicates*, Nature. (345), p. 486.
- [27†] Dunsmore, H.E., **1992**, *A geological perspective on global warming and the possibility of carbon dioxide removal as calcium carbonate mineral*, Energy Conversion and Management. (33), pp. 565-572.
- [28†] Lackner, K.S., Butt, D.P., Wendt, C.H., **1997**, *Progress on binding CO<sub>2</sub> in mineral substrates*, Energy Conversion and Management. (38), pp. 259-264.
- [29†] Lackner, K.S., **2002**, *Carbonate chemistry for sequestering fossil carbon*, Annu. Rev. Energy Environ. (27), pp. 193-232.

- [30†] Butt, D.P., Lackner, K.S., Wendt, C.H., Vaidya, R., Piled, L., Park, Y., Holesinger, T., Harradine, D.M., Nomura, K., **1998**, *The kinetics of binding carbon dioxide in magnesium carbonate*, Proceedings of the 23<sup>rd</sup> international technical conference on coal utilization and fuel systems, 9-13 March, 1998, Clearwater, FL, USA.
- [31†] Butt, D.P., Lackner, K.S., Wendt, C.H., Conzone, S.D., Kung, H., Lu, Y.-C., Bremser, J.K., **1996**, *Kinetics of thermal dehydroxylation and carbonation of magnesium hydroxide*, Journal of the American Ceramic Society. (7), pp. 1892-1898.
- [32†] Kojima, T., Nagamine, A., Ueno, N., Uemiya, S., **1997**, *Absorption and fixation of carbon dioxide by rock weathering*, Energy Conversion and Management. (38), pp. 461-466.
- [33†] IEA GHG, **2000**, *CO<sub>2</sub> storage as carbonate minerals*, PH3/17, CSMA Consultants Ltd, United Kingdom, Cheltenham.
- [34†] Zevenhoven, R., Kavaliauskaite, I., **2004**, *Mineral carbonation for long-term CO<sub>2</sub> storage: An exergy analysis*, International Journal of Thermodynamics. (7), pp. 22-31.
- [35] Zevenhoven, R., Teir, S., Eloneva, S., **2006**, *Heat optimisation of a staged gas-solid mineral carbonation process for long-term CO<sub>2</sub> storage*, Proceedings of ECOS 2006, 12-14 July 2006, Crete, Greece, pp. 1661-1669, in revised form Energy (33), 2008, pp. 362-370.
- [36†] Zevenhoven, R., Tier, S., **2004**, *Long term storage of CO<sub>2</sub> as magnesium carbonate in Finland*, Proceedings of the Third Annual Conference on Carbon Capture and Sequestration, May 3-6, 2004, Alexandria (VA), USA, (paper 217).
- [37] Zevenhoven, R., Eloneva, S., Teir, S., **2006**, *A study on MgO-based mineral carbonation kinetics using pressurised thermogravimetric analysis*, 8<sup>th</sup> International Conference on Greenhouse Gas Control Technologies, 19-22 June, 2006, Trondheim, Norway, paper P02\_01\_09.
- [38†] O'Connor, W.K., Dahlin, D.C., Nilsen, R.P., Turner, P.C., **2000**, *Carbon dioxide sequestration by direct mineral carbonation with carbonic acid*, Proceedings of the 25<sup>th</sup> International Technical Conf. On Coal Utilization & Fuel Systems, Coal Technology Assoc. March 6-9, Clear Water, FL, Albany Research Center, Albany, Oregon.
- [39] Munz, I.A., Korneliussen, A., Gorset, O., Johansen, H., Kihle, J., Flaathen, T., Sandvik, K., **2006**, *Added value of industrial minerals and CO<sub>2</sub> storage: New possibilities for Norwegian mineral industry*, 8<sup>th</sup> International Conference on Greenhouse Gas Control Technologies, 19-22 June, Trondheim, Norway, (Paper P02\_01\_12).
- [40†] Herzog, H., **2002**, *Carbon sequestration via mineral carbonation: Overview and assessment*, MIT Laboratory for Energy and the Environment, MIT (MA), USA, March, 2002.
- [41†] Béarat, H., McKelvy, M.J., Chizmeshya, A.V.G., Sharma, R., Carpenter, R.W., **2002**, *Magnesium hydroxide dehydroxylation/carbonation reaction processes: Implications for carbon dioxide mineral sequestration*, J. Amer. Ceram. Soc. (4), pp. 742-748.
- [42†] McKelvy, M.J., Chizmesya, A.V.G., Diefenbacher, J., Béarat, H., Wolf, G., **2004**, *Exploration of the role of heat activation in enhancing serpentine carbon sequestration reactions*, Environmental Science & Technology. (38), pp. 6897-6903.
- [43†] Blencoe, J.G., Palmer, D.A., Anovitz, L.M., Beard, J.S., **2004**, *Carbonation of metal silicates for long-term CO<sub>2</sub> sequestration*, WO 2004/094043.

- [44†] Park, A.A., Fan, L., **2004**, *CO<sub>2</sub> mineral sequestration: Physically activated dissolution of serpentine and pH swing process*, Chemical Engineering Science. (59), pp. 5241-5247.
- [45†] Kakizawa, M., Yamasaki, A., Yanagisawa, Y., **2001**, *A new CO<sub>2</sub> disposal process via artificial weathering of calcium silicate accelerated by acetic acid*, Energy. (26), pp. 341-354.
- [46†] Yogo, K., Teng, Y., Yashima, T., Yamade, K., **2004**, *Development of a new CO<sub>2</sub> fixation/utilization process (1): Recovery of calcium from steelmaking slag and chemical fixation of carbon dioxide by carbonation reaction*, 7<sup>th</sup> International Conference on Greenhouse Gas Control Technologies, 5-9 September, 2004, Vancouver, BC, Canada, (poster).
- [47†] Lackner, K.S., Ziock, H.-J., Grimes, P., **1999**, *Carbon dioxide extraction from air: Is it an option?* 24<sup>th</sup> International Conference on Coal Utilization & Fuel Systems, March 8-11, 1999, Clearwater (FL), USA.
- [48†] Lackner, K.S., Grimes, P., Ziock, H.-J., **2001**, *Capturing carbon dioxide from air*, First National Conference on Carbon Sequestration, May 14-17, 2001, Washington, DC, USA.
- [49] Bearat, H., McKelvy, M.J., Chizmeshya, A.V.G., Gormley, D., Nunez, R., Carpenter, R.W., Squires, K., Wolf, G.H., **2006**, *Carbon sequestration via aqueous olivine mineral carbonation: Role of passivating layer formation*, Environ. Sci. Technol. (40), pp. 4802-4808.
- [50] Chen, Z.Y., O'Connor, W.K., Gerdemann, S.J., **2006**, *Chemistry of aqueous mineral carbonation for carbon sequestration and explanation of experimental results*, Environmental Progress. (25), pp. 161-166.
- [51] Huijgen, W.J.J., Ruijg, G.J., Comans, R.N.J., Witkamp, G.J., **2006**, *Energy consumption and net CO<sub>2</sub> sequestration of aqueous mineral carbonation*, Ind. Eng. Chem. Res. (45), pp. 9184-9194.
- [52] Hänchen, M., Prigiobbe, V., Baciocchi, R., Mazzotti, M., **2008**, *Precipitation in the mg-carbonate system – effects of temperature and CO<sub>2</sub> pressure*, Chemical Engineering Science. (63), pp. 1012-1028.
- [53†] Kohlmann, J., Zevenhoven, R., Mukherjee, A.B., Koljonen, T., **2002**, *Mineral carbonation for long-term storage of CO<sub>2</sub> from flue gases*, TKK-ENY-9, Helsinki University of Technology, Energy Engineering and Environmental Protection, Finnish National Research Programme CLIMTECH (1999-2002).
- [54] Rendek, E., Ducom, G., Germain, P., **2006**, *Carbon dioxide sequestration in municipal solid waste incinerator (MSWI) bottom ash*, Journal of Hazardous Materials. (128), pp. 73-79.
- [55] Zevenhoven, R., Teir, S., Eloneva, S., Aatos, S., Sorjonen-Ward, P., **2007**, *CO<sub>2</sub> sequestration by carbonation of minerals and industrial by-products in Finland*, Proc. of R'07, Sept. 3-5, 2007, Davos (Switzerland), paper 72.
- [56] Teir, S., Revitzer, H., Eloneva, S., Fogelholm, C.-J., Zevenhoven, R., **2007**, *Dissolution of natural serpentine in mineral and organic acids*, International Journal of Mineral Processing. (83), pp. 36-46.



- [57] Teir, S., Eloneva, S., Zevenhoven, R., **2005**, *Production of precipitated calcium carbonate from calcium silicates and carbon dioxide*, Energy Conversion and Management. (46), pp. 2954-2979.
- [58] Teir, S., Eloneva, S., Fogelholm, C.-J., Zevenhoven, R., **2007**, *Dissolution of steelmaking slags in acetic acid for precipitated calcium carbonate production*, Energy. (32), pp. 528-539.
- [59] Teir, S., Kuusik, R., Fogelholm, C.-J., Zevenhoven, R., **2007**, *Production of magnesium carbonates from serpentinite for long-term storage of CO<sub>2</sub>*, Int. J. of Miner. Proc. (85), pp. 1-15.
- [60] Eloneva, S., Teir, S., Savolahti, J., Fogelholm, C.-J., Zevenhoven, R., **2007**, *Co-utilization of CO<sub>2</sub> and calcium silicate-rich slags for precipitated calcium carbonate production (part II)*, ECOS'2007, June 25-28, 2007, Padova, Italy, Vol. II, pp. 1389-1396.
- [61] Rendek, E., Ducom, G., Germain, P., **2007**, *Influence of waste input and combustion technology on MSWI bottom ash quality*, Waste Management. (27), pp. 1403-1407.
- [62] Baciocchi, R., Polettini, A., Pomi, R., Prigiobbe, V., Zedtwitz-Nikulshyna, V., Steinfeld, A., **2006**, *Performance and kinetics of CO<sub>2</sub> sequestration by direct gas-solid carbonation of APC residues*, 8<sup>th</sup> International Conference on Greenhouse Gas Control Technologies, 19-22 June, Trondheim, Norway.
- [63†] Lackner, K.S., **2003**, *CLIMATE CHANGE: A guide to CO<sub>2</sub> sequestration*, Science. (300), pp. 1677-1678.
- [64] McKelvy, M.J., Chizmeshya, A.V.G., Squires, K.D., Carpenter, R.W., Béarat, H., **2006**, *A novel approach to mineral carbonation: Enhancing carbonation while avoiding mineral pretreatment process cost*, Arizona State University, Center for Solid State Science, Science and Engineering of Materials Graduate Program, and Department of Mechanical and Aerospace Engineering, June 22, 2005 - June 21, 2005.
- [65] Van Essendelft, D.T., Gafarova-Aksoy, P., Schobert, H.H., **2006**, *Carbon dioxide capture by aqueous mineral carbonation for industrial and large-scale operations*, 8<sup>th</sup> International Conference on Greenhouse Gas Control Technologies, 19-22 June, Trondheim, Norway.
- [66] Kodama, S., Nishimoto, T., Yogo, K., Yamada, K., **2006**, *Design and evaluation of a new CO<sub>2</sub> fixation process using alkaline-earth metal wastes*, 8<sup>th</sup> International Conference on Greenhouse Gas Control Technologies, 19-22 June, Trondheim, Norway.
- [67] McKelvy, M.J., Chizmeshya, A.V.G., Soignard, E., Marzke, R., Wolf, G.H., Béarat, H., Doss, B., **2006**, *Laboratory investigation of Fluid/Solid sequestration reaction processes under in situ sequestration process conditions*, 31<sup>st</sup> International Technical Conference on Coal Utilization & Fuel Systems, May 21-26, 2006, Clearwater, Florida, USA, (paper 41), pp. 384-400.
- [68] Soignard, E., Robert Marzke, R., Piwowarczyk, J., Diefenbacher, J., McKelvy, M.J., **2006**, *Application of NMR to the direct measurement of diffusivities and activities of CO<sub>2</sub> and other dissolved species under geological and mineral sequestration conditions*, 31<sup>st</sup> International Technical Conference on Coal Utilization & Fuel Systems, May 21-26, 2006, Clearwater, Florida, USA, (paper 42), p. 401.

- [69] Chizmeshya, A.V.G., McKelvy, M.J., Marzke, R., Ito, N., Wolf, G., Béarat, H., Doss, B., **2007**, *Investigating geological sequestration reaction processes under in situ process conditions*, 32<sup>nd</sup> International Technical Conference on Coal Utilization & Fuel Systems, June 10-15, 2007, (paper 44), p. 441.
- [70] Hansen, L.D., Dipple, G.M., Gordon, T.M., Kellett, D.A., **2005**, *Carbonated serpentinite (listwanite) at Atlin, British Columbia: A geological analogue to carbon dioxide sequestration*, *Can. Mineral.* (43), pp. 225-239.
- [71] Hänchen, M., Krevor, S., Mazzotti, M., Lackner, K., **2007**, *Validation of a population balance model for olivine*, *Chemical Engineering Science.* (62), pp. 6412-6422.
- [72] Hänchen, M., Prigiobbe, V., Storti, G., Mazzotti, M., **2007**, *Mineral carbonation: Kinetic study of olivine dissolution and carbonate precipitation*, 8<sup>th</sup> International Conference on Greenhouse Gas Control Technologies, 19-22 June, 2007, Trondheim, Norway, paper 01\_013\_04.
- [73] Hänchen, M., Prigiobbe, V., Storti, G., Seward, T.M., Mazzotti, M., **2006**, *Dissolution kinetics of fosteritic olivine at 90–150 °C including effects of the presence of CO<sub>2</sub>*, *Geochimica et Cosmochimica Acta.* (70), pp. 4403-4416.
- [74] Yajima, T., Okamoto, I., Ohsumi, T., Ninomiya, A., Yukihiro, M., Takayuki, K., **2006**, *Experimental studies of CO<sub>2</sub> fixation by serpentinite*, 8<sup>th</sup> International Conference on Greenhouse Gas Control Technologies, 19-22 June, Trondheim, Norway, (poster).
- [75] Domingo, C., Loste, E., Gómez-Morales, J., García-Carmona, J., Fraile, J., **2006**, *Calcite precipitation by a high-pressure CO<sub>2</sub> carbonation route*, *The Journal of Supercritical Fluids.* (36), pp. 202-215.
- [76] Back, M., Vosbeck, K., Kühn, M., Stanjek, H., Clauser, C., Peiffer, S., **2006**, *Pretreatment of CO<sub>2</sub> with fly ashes to generate alkalinity for subsurface sequestration*, 8<sup>th</sup> International Conference on Greenhouse Gas Control Technologies, 19-22 June, Trondheim, Norway.
- [77] Saha, K.K., Squires, K.D., McKelvy, M.J., **2007**, *Simulation and modeling of a slurry mixture for applications to carbon-dioxide sequestration*, 6<sup>th</sup> International Conference on Multiphase Flow, ICMF 2007, Leipzig, Germany.
- [78] Penner, L.R., Dahlin, D.C., Gerdemann, S.J., Saha, K.K., **2005**, *Modeling flow of mineralized carbon dioxide slurry*, 056, DOE/ARC, Albany Research Center.
- [79] Huijgen, W.J.J., Witkamp, G., Comans, R.N.J., **2006**, *Mechanisms of aqueous wollastonite carbonation as a possible CO<sub>2</sub> sequestration process*, *Chemical Engineering Science.* (61), pp. 4242-4251.
- [80†] O'Connor, W.K., Dahlin, D.C., Nilsen, D.N., Rush, G.E., Walters, R.P., Turner, P.C., **2001**, *Carbon dioxide sequestration by direct mineral carbonation: Results from recent studies and current status*, First National Conference on Carbon Sequestration, May 14-17, Washington, DOE/ARC-2001-029, National Energy Technology Laboratory, U.S. Department of Energy.
- [81] Kleiv, R.A., Thornhill, M., **2006**, *Mechanical activation of olivine*, *Minerals Engineering.* (19), pp. 340-347.

- [82†] O'Connor, W.K., Dahlin, D.C., Rush, S.J., Gerdemann, S.J., Penner, L.R., **2004**, *Energy and economic considerations for ex-situ aqueous mineral carbonation*, DOE/ARC-2004-028, U.S. Department of Energy, Albany Research Center, Albany, Oregon.
- [83] O'Connor, W.K., Dahlin, D.C., Rush, G.E., Gerdemann, S.J., Penner, L.R., Nilsen, R.P., **2005**, *Aqueous mineral carbonation: Mineral availability, pretreatment, reaction parametrics, and process studies*, DOE/ARC-TR-04-002, Albany Research Center, Albany, New York.
- [84] McKelvy, M.J., Chizmeshya, A.V.G., Squires, K.D., Saha, K.K., Béarat, H., Firas, A., Karalee, J., Carpenter, R.W., Kim, Y., Penner, L.R., Dahlin, D.C., **2006**, *Enhancing aqueous olivine carbonation reactivity, while avoiding the cost of mineral pretreatment activation*, Fifth Annual Conference on Carbon Capture & Sequestration, May 8-11, Alexandria, VA, USA, (Presentation).
- [85] Alexander, G., Maroto-Valer, M.M., Gafarova-Aksoy, P., **2007**, *Evaluation of reaction variables in the dissolution of serpentine for mineral carbonation*, Fuel. (86), pp. 273-281.
- [86] Teir, S., Eloneva, S., Zevenhoven, R., **2005**, *Reduction of CO<sub>2</sub> emissions by calcium carbonate production from calcium silicates*, PRES'05, May 15-18, 2005, Giardini di Naxos / Messina, Italy, Chem. Eng. Trans. 7 (2005) Vol. 2, pp. 571-576.
- [87] Teir, S., Eloneva, S., Fogelholm, C.-J., Zevenhoven, R., **2007**, *Carbonation of minerals and industrial by-products for CO<sub>2</sub> sequestration*, IGEC-III, June 18-20, 2007, Västerås, Sweden.
- [88] Katsuyama, Y., Yamasaki, A., Iizuka, A., Fujii, M., Kumagai, K., Yanagisawa, Y., **2005**, *Development of a process for producing high-purity calcium carbonate (CaCO<sub>3</sub>) from waste cement using pressurized CO<sub>2</sub>*, Environmental Progress. (24), pp. 162-170.
- [89] Geerlings, J.J.C., Van Mossel, G.A.F., In't Veen, B.C.M., **2007**, *Process for sequestration of carbon dioxide*, Patent, PCT/EP2006/069796, 28.06.2007.
- [90] Gorset, O., Johansen, H., Kihle, J., Munz, I.A., Raaheim, A., **2007**, *Method for industrial manufacture of pure MgCO<sub>3</sub> from an olivine containing species of rock*, Patent, WO/2007/069902, 21.6.2007.
- [91] Yogo, K., Eikou, T., Tateaki, Y., **2005**, *Method for fixing carbon dioxide*, Patent, JP2005097072, 14.4.2005.
- [92] Teir, S., Revitzer, H., Eloneva, S., Savolahti, J., Fogelholm, C.-J., Zevenhoven, R., **2007**, *Fixation of CO<sub>2</sub> by dissolution of serpentinite and precipitation of magnesium carbonates*, ECOS'2007, June 25-28, 2007, Padova, Italy, Vol. II, pp. 1333-1340.
- [93] Cheng, T.W., Hsu, C.W., **2006**, *A study of silicon carbide synthesis from waste serpentine*, Chemosphere. (64), pp. 510-514.
- [94] Feng, B., Yong, A.K., An, H., **2007**, *Effect of various factors on the particle size of calcium carbonate formed in a precipitation process*, Materials Science and Engineering: A. (445-446), pp. 170-179.
- [95†] Jones, A., Glass, C., Reddy, T.K., Maroto-Valer, J.M., Andrésen, J.M., Schobert, H.H., **2001**, *Preprints of papers - American Chemical Society*, Division of Fuel Chemistry 46 (1) 321, taken from [96].

- [96] Druckenmiller, M.L., Maroto-Valer, M.M., **2005**, *Carbon sequestration using brine of adjusted pH to form mineral carbonates*, Fuel Processing Technology. (86), pp. 1599-1614.
- [97] Soong, Y., Fauth, D.L., Howard, B.H., Jones, J.R., Harrison, D.K., Goodman, A.L., Gray, M.L., Frommell, E.A., **2006**, *CO<sub>2</sub> sequestration with brine solution and fly ashes*, Energy Conversion and Management. (47), pp. 1676-1685.
- [98†] Rau, G.H., Caldeira, K., **1999**, *Enhanced carbonate dissolution: A means of sequestering waste CO<sub>2</sub> as ocean bicarbonate*, Energy Conversion and Management. (40), pp. 1803-1813.
- [99] Rau, G.H., Knauss, K.G., Langer, W.H., Caldeira, K., **2007**, *Reducing energy-related CO<sub>2</sub> emissions using accelerated weathering of limestone*, Energy. (32), pp. 1471-1477.
- [100] Stolaroff, J.K., Lowry, G.V., Keith, D.W., **2005**, *Using CaO- and MgO-rich industrial waste streams for carbon sequestration*, Energy Conversion and Management. (46), pp. 687-699.
- [101] Schuiling, R.D., Krijgsman, P., **2006**, *Enhanced weathering: An effective and cheap tool to sequester CO<sub>2</sub>*, Climatic Change. (74), pp. 349-354.
- [102] Schuiling, R.D., **2006**, *Mineral sequestration of CO<sub>2</sub> and recovery of the heat of reaction*, in: Badescu V, Cathcart RB, Schuiling RD (Eds.), Macro-engineering - A challenge for the future, Springer Dordrecht, the Netherlands, pp. 21-29 (chapter 2).
- [103] Wilson, S.A., Raudsepp, M., Dipple, G.M., **2006**, *Verifying and quantifying carbon fixation in minerals from serpentine-rich mineral tailings using the Rietveld method with X-ray powder diffraction data*, Amer. Mineral. (91), pp. 1331-1341.
- [104] Maroto-Valer, M.M., Fauth, D.J., Kuchta, M.E., Zhang, Y., Andrésen, J.M., **2005**, *Activation of magnesium rich minerals as carbonation feedstock materials for CO<sub>2</sub> sequestration*, Fuel Processing Technology. (86), pp. 1627-1645.
- [105] Geerlings, J.J.C., Wesker, E., **2007**, *A process for sequestration of carbon dioxide by mineral carbonation*, Patent, PCT/EP2006/068691, 31.05.2007.
- [106] Huijgen, W.J.J., Comans, R.N.J., Witkamp, G., **2007**, *Cost evaluation of CO<sub>2</sub> sequestration by aqueous mineral carbonation*, Energy Conversion and Management. (48), pp. 1923-1935.
- [107†] Iizuka, A., Fujii, M., Yamasaki, A., Yanagisawa, Y., **2004**, *Development of a new CO<sub>2</sub> sequestration process utilizing the carbonation of waste cement*, Ind. Eng. Chem. Res. (43), pp. 7880-7887.
- [108] Khoo, H.H., Tan, R.B.H., **2006**, *Life cycle evaluation of CO<sub>2</sub> recovery and mineral sequestration alternatives*, Environmental Progress. (25), pp. 208-217.
- [109] IPCC, **2007**, *Climate change 2007: Mitigation of climate change. contribution of working group III to the fourth assessment report of the intergovernmental panel on climate change*, in: Metz B, Davidson O, Bosch P, Dave R, Meyer L (Eds.), Cambridge University Press, Cambridge, United Kingdom and New York(NY), USA.
- [110] Lovelock, J., **2006**, *The revenge of Gaia*, Allan Lane, UK (Penguin books, 2007).

- [111†] Rubin, E.S., Rao, A.B., Chen, C., **2004**, *Comparative assessments of fossil fuel power plants with CO<sub>2</sub> capture and storage*, 7<sup>th</sup> International Conference on Greenhouse Gas Control Technologies, 5-9 September, 2004, Vancouver, BC, Canada, paper 475.
- [112†] Baehr, H.D., **1988**, *Thermodynamik*, Berlin: Springer Verlag.
- [113†] Szargut, J., Morris, D., Steward, F.R., **1988**, *Exergy analysis of thermal, chemical and metallurgical processes*, New York: Hemisphere Publishing Co.
- [114†] De Swaan Arons, J., van der Kooi, H., Sankaranarayanan, K., **2004**, *Efficiency and sustainability in the efficiency and chemical industries*, New York: Marcel Dekker.
- [115] Kavaliauskaite, I., Denafas, G., **2006**, *Carbonization of natural resources – as an option for carbon dioxide storage in Lithuania*, 8<sup>th</sup> International Conference on Greenhouse Gas Control Technologies, 19-22 June, Trondheim, Norway, (Paper P02\_01\_11).
- [116] Aatos, S., Sorjonen-Ward, P., Kontinen, A., Kuivasaari, T., **2006**, *Outlooks for utilisation of serpentine and serpentinite (serpentiinin ja serpentiniitin hyötykäyttönäkymiä)*, M10.1/2006/3 (in Finnish), Geological Survey of Finland (GSF), Kuopio, Finland.
- [117] Hršak, D., Malina, J., Hadžipašić, A.B., **2005**, *The decomposition of serpentine by thermal treatment*, *Materiali in Technologije*. (39), pp. 225-227.
- [118] Yamasaki, A., Iizuka, A., Kakizawa, M., Katsuyama, Y., Nakagawa, M., Fujii, M., Kumagai, K., Yanagisawa, Y., **2006**, *Development of a carbon sequestration process by the carbonation reaction of waste streams containing calcium or magnesium*, Fifth Annual Conference on Carbon Capture & Sequestration, May 8-11, Alexandria, Virginia, USA.
- [119] Tans, P., **2007** (2007), *Trends in atmospheric carbon dioxide - Mauna Loa*, NOAA/ESRL, <http://www.esrl.noaa.gov/gmd/ccgg/trends/>.
- [120] Maslennikov, A., **2007** (2007), *Acid news - Carbon capture...* The Swedish NGO Secretariat on Acid rain, <http://www.acidrain.org/pages/publications/acidnews/2007/documents/AN2-07.pdf>.
- [121] IEA GHG, **2007**, *Greenhouse issues*, IEA Greenhouse Gas R&D Programme. (87), pp. 5-6. See also Report IEA GHG 2007/11.
- [122†] Goldberg, P., **2001**, *CO<sub>2</sub> mineral sequestration studies*, Mineral Carbonation Workshop, U.S. Department of Energy, National Energy Technology Laboratory, August 8, 2001.

## Appendix

### Energy efficiency of mineral carbonation processes.

The efficiency of fixation of CO<sub>2</sub> by mineral carbonation (and also other long-term CO<sub>2</sub> storage methods) can be assessed by considering the use of power and heat by the process. Ultimately, the power and heat used are presumably produced by fossil energy conversion in a combustion process which will result in the production of CO<sub>2</sub>. Huijgen [19,51] suggested a simple model expression for an “energetic CO<sub>2</sub> sequestration efficiency”:

$$\eta(\text{CO}_2) = \frac{\text{CO}_2 \text{ avoided}}{\text{CO}_2 \text{ sequestered}} \times 100 \% = 100 - \frac{E_{\text{power}} \cdot \varepsilon_{\text{power}} + E_{\text{heat}} \cdot \varepsilon_{\text{heat}}}{\text{CO}_2 \text{ sequestered}} \times 100 \% \quad (\text{A1})$$

where  $E_{\text{power}}$  and  $E_{\text{heat}}$  are the amounts of power and heat used in the carbonation process (kWh) and  $\varepsilon_{\text{power}}$  and  $\varepsilon_{\text{heat}}$  give the amounts of CO<sub>2</sub> produced when generating the necessary amounts of heat (kg CO<sub>2</sub>/kWh). Following Rubin *et al.* [111†], the value for  $\varepsilon_{\text{power}}$  was taken to be 0.6 kg CO<sub>2</sub>/kWh (an average value for a natural gas fired combined cycle system, 0.36 kg CO<sub>2</sub>/kWh, and a condensing pulverized coal fired power plant, 0.8 kg CO<sub>2</sub>/kWh). For  $\varepsilon_{\text{heat}}$  the value 0.2 kg CO<sub>2</sub>/kWh (based on methane combustion) was used. Using this, Huijgen found efficiencies of approximately 75% for wollastonite carbonation and around 69% for steel slag carbonation, respectively, using an aqueous process.

A more general assessment can be made when considering process heat in more detail. Besides power consumption  $E_{\text{power}}$  (which may in theory be <0 if excess process heat can be used to generate power) the process heat streams can be separated into ingoing heat streams  $Q_{\text{in}}$ , outgoing heat streams  $Q_{\text{out}}$  and heat losses  $Q_{\text{losses}}$ , each at a given temperature. Exergy analysis (based on the Second Law of Thermodynamics) allows for calculating the maximum power that can be produced from a certain amount of heat,  $Q$ , at temperature  $T$ , at temperature of the surroundings,  $T_0$ , by calculating its so-called exergy:

$$\text{Ex}(Q) = Q \cdot \left(1 - \frac{T_0}{T}\right) \quad (\text{A2})$$

where the temperatures must be taken in K. This quantifies for how much “useful energy”, (*i.e.* work) can be obtained by converting heat into power, taking into account the quality of the heat as given by its temperature with respect to the surrounding environment (see *e.g.* [112†-114†]). For power,  $P$ , the exergy is equal to the energy:  $\text{Ex}(P) = P$ .

For a carbonation process with  $n_i$  ingoing heat streams  $Q_{\text{in},i}$  at temperatures  $T_{\text{in},i}$ ,  $n_j$  outgoing heat streams  $Q_{\text{out},j}$  at temperatures  $T_{\text{out},j}$ , and  $n_k$  heat losses streams  $Q_{\text{losses},k}$  at temperatures  $T_{\text{loss},k}$ , a more general expression for  $\eta(\text{CO}_2)$  can be given, using exergies only:

$$\eta(\text{CO}_2) = \frac{\text{CO}_2 \text{ avoided}}{\text{CO}_2 \text{ sequestered}} \times 100 \% = \left( 1 - \frac{\left[ E_{\text{power}} - \sum_j \xi_j \cdot Q_{\text{out},j} \cdot \left(1 - \frac{T_0}{T_{\text{out},j}}\right) \right] + \left[ \sum_i Q_{\text{in},i} \cdot \left(1 - \frac{T_0}{T_{\text{in},i}}\right) - \sum_j (1 - \xi_j) \cdot Q_{\text{out},j} \cdot \left(1 - \frac{T_0}{T_{\text{out},j}}\right) + \sum_k Q_{\text{losses},k} \cdot \left(1 - \frac{T_0}{T_{\text{losses},k}}\right) \right]}{\text{CO}_2 \text{ sequestered}} \cdot \varepsilon_{\text{power}} \right) \times 100 \% \quad (\text{A3})$$

where the parameter  $0 \leq \xi_j \leq 1$  gives the fraction of an outgoing heat stream  $Q_{\text{out},j}$  that is converted into power. In the study by Huijgen, no heat losses were considered ( $n_k=0$ ), one ingoing heat stream ( $n_i=1$ , preheating of to carbonation temperature) and one outgoing heat stream ( $n_j=1$ , reaction heat) were considered, and no excess heat was converted into power (all  $\xi_j = 0$ ). This reduces the above equation to

$$\eta(\text{CO}_2) = \frac{\text{CO}_2 \text{ avoided}}{\text{CO}_2 \text{ sequestered}} \times 100 \% = \left( 1 - \frac{E_{\text{power}} + \left[ Q_{\text{in}} \cdot \left(1 - \frac{T_0}{T_{\text{in}}}\right) - Q_{\text{out}} \cdot \left(1 - \frac{T_0}{T_{\text{out}}}\right) \right]}{\text{CO}_2 \text{ sequestered}} \cdot \varepsilon_{\text{power}} \right) \times 100 \% \quad (\text{A4})$$

where  $T_{\text{out}}$  of  $Q_{\text{out}}$  is the temperature of the carbonation reactor  $T_R$ , and  $T_{\text{in}}$  for the heat used in the preheater should be slightly higher than that. With  $T_{\text{out}} = T_R \approx T_{\text{in}}$ , the expression simplifies to

$$\eta(\text{CO}_2) = \frac{\text{CO}_2 \text{ avoided}}{\text{CO}_2 \text{ sequestered}} \times 100 \% = \left( 1 - \frac{E_{\text{power}} + \left[ (Q_{\text{in}} - Q_{\text{out}}) \cdot \left(1 - \frac{T_0}{T_R}\right) \right]}{\text{CO}_2 \text{ sequestered}} \cdot \varepsilon_{\text{power}} \right) \times 100 \% \quad (\text{A5})$$

This is identical to the original expression by Huijgen for net heat input  $E_{\text{heat}} = Q_{\text{in}} - Q_{\text{out}}$ , and  $\varepsilon_{\text{heat}} = (1 - T_0/T_R) \cdot \varepsilon_{\text{power}}$ . For the values  $\varepsilon_{\text{heat}} = 0.2 \text{ kg CO}_2/\text{kWh}$  and  $\varepsilon_{\text{power}} = 0.6 \text{ kg CO}_2/\text{kWh}$ , and carbonation reaction temperature  $T_R = 150\text{--}200 \text{ }^\circ\text{C}$  this gives  $T_0 = 9\text{--}42 \text{ }^\circ\text{C}$  for the temperature of the environment, showing that the estimate of  $\varepsilon_{\text{heat}}$  for the given  $\varepsilon_{\text{power}}$  is rather good. The power use was related to grinding the material to be carbonated to the appropriate particle size, compression of the  $\text{CO}_2$  and pumping slurries. Power consumptions related to the reactor and for filtration were neglected. Using the relation  $\varepsilon_{\text{heat}} = \varepsilon_{\text{power}} \cdot (1 - T_0/T)$  in (A5) gives the expression (A1) suggested by Huijgen, but it must be noted that for heat streams  $E_{\text{heat}}$  of different temperature the factors  $\varepsilon_{\text{heat}}$  are different.

This analysis shows that it is important to make the distinction between power and heat as well as the temperature of the various process heat streams of the process. For heating purposes it is not necessary and in fact unwise to use electric power, as it is sufficient to use heat of sufficiently high temperature, which should have a much lower cost. At a power or steel plant that would mean using process heat instead of electricity.

In the system study on aqueous mineral carbonation at Albany Research Center (ARC) in the U.S. [22,83] no distinction is made between heat and power use while evaluating energy use and the

efficiency of the processes. Three cases are considered: 1) carbonation of olivine at 185 °C, 150 atm, 2) carbonation of heat treated serpentine at 155 °C, 115 bar, and 3) carbonation of wollastonite at 100 °C, 40 bar. (For the Mg-based the carrier solution is 0.64 M NaHCO<sub>3</sub> + 1 M NaCl in distilled water; for the Ca-based material the carrier solution was distilled water.)

In the study, several levels of mechanical pre-treatments were considered, 1) initial crushing, 2) grinding to < 75 µm, 3) grinding to < 38 µm and 4) high intensity grinding in a so-called SMD (stirred media detritor) mill, to < 10 µm ( $D_{50} \sim 5 \mu\text{m}$ ). The required energy input for these were 1) 2 kWh/t, 2) 11 kWh/t, 3) 70 kWh/t and 4) 150 kWh/t. Besides this, after the initial crushing beneficiation (e.g. gravity separation) may be used for materials of much less than < 100% purity. Noted below as mechanical pre-treatment 1b) this would require 2 kWh/t for a 70% pure olivine, and 4 kWh/t for a 50% pure wollastonite. For the two serpentine (lizardite and antigorite) samples, heat treatment at 630 °C for 2 h was necessary to remove chemically bound water and produce a pseudo-amorphous material; this required 326 kWh/t for the lizardite serpentine and 293 kWh/t for the antigorite serpentine.

Table A1. Energy requirements as heat, power and exergy for mineral pre-treatment in the ARC study [22,83].

	#	Mechanical Pre-treatment	Power input kWh/t	Thermal Pre-treatment	Heat input kWh/t	Total energy input kWh/t	Power input exergy kWh/t	Heat input exergy* kWh/t	Total exergy* input kWh/t
Olivine 100%	1	1+2	13			13	13		13
	2	1+2+3	83			83	83		83
	3	1+2+3+4	233			233	233		233
Serpentine/lizardite 100%	4	1+2	13			13	13		13
	5	1+2	13	630 °C, 2 h	326	339	13	222	235
Olivine 70%	6	1+1a+2	19			19	19		19
	7	1+1a+2+3	89			89	89		89
	8	1+1a+2+3+4	239			239	239		239
Serpentine/antigorite 100%	9	1+2	13			13	13		13
	10	1+2	13	630 °C, 2 h	293	306	13	199	212
	11	1+2+3	83	630 °C, 2 h	293	376	83	199	282
Wollastonite 50%	12	1+1b+2+3	97			97	97		97
	13	1+1b+2+3+4	167			167	167		167

\* Assuming a temperature of the environment  $T_0 = 15 \text{ °C} = 288 \text{ K}$

Table A1 summarizes the energy input requirement for the pre-treatment stages for the various tests, according to [22,83], see also [6, p. 326]. In the table, the exergy of the 630 °C heat is found using eqn. (A2), with heat quality factor  $(1-T_0/T) = 0.68$ , assuming  $T_0 = 288 \text{ K}$  (15 °C).

This shows that the energy input requirements are overestimated by ~ 30% if it is assumed that heat can be used for the thermal pre-treatment instead of electricity. This puts the energy penalty for thermal pre-heating to the same level as grinding from < 75 µm to < 10 µm.



Moreover, the need for a thermal pre-treatment duration as long as 2 h can be questioned. Recent work (not yet published) by Helsinki University of Technology / Åbo Akademi University with 75–125  $\mu\text{m}$  serpentinite from Finland in a thermobalance (at 630 °C, in air at 1 atm) showed that the mass loss related to loss of chemically bound water is  $\sim 90\%$  complete after 30 min, and (close to) 100% after 1 h. Cutting the time of 2 h thermal pre-treatment to, say,  $\frac{1}{3}$  (40 min) would reduce the exergy input requirements to 65–75 kWh/t (or: 80–110 kWh/t heat at 630 °C).

As a third omission, the heat produced by carbonation reaction is not taken into account as this is presumably not considered to be useful or relevant. Huijgen [19,51] however, as mentioned above showed that this heat production is very similar to the heat needed for pre-heating the material stream that goes into the reactor. It is not unlikely that the ARC team, for this reason, considered these two heat effects to cancel each other out, and did not include these heat effects in the cost evaluation. On the other hand, the ARC team did primarily consider energy effects that involved a significant power consumption (accounting also for thermal pre-treatment of serpentine as electricity consumption.)

Finally, all this can be related to costs, which are lower for process heat than for electricity. The ARC study uses an electricity price of  $\sim 0.05$  US\$/kWh. Using coal with typical heating value of 28 MJ/kg (LHV) in a typical pulverized coal condensing power plant with  $\sim 40\%$  thermal efficiency (*i.e.* the rate of conversion of chemical energy in the fuel to electricity, via heat) will result in an electricity production of 11.2 MJ/kg = 3.1 kWh/kg coal, whilst for heat of 630 °C the production will be 25.2 MJ/kg = 7 kWh/kg coal (assuming a rate of (more than)  $\sim 90\%$  for conversion of chemical energy in the fuel to heat). This shows a factor of  $\sim 2.3$  in fuel consumption for coal-derived electricity or heat; repeating the calculation for a natural gas-fired combined cycle plant with  $\sim 50\%$  thermal efficiency (but about 3 times higher fuel costs expressed as US\$/kWh) shows a factor of  $\sim 1.8$ . In general therefore, a cost reduction by a factor of 2 must be taken into account when using process heat instead of electricity for the thermal pre-treatment of serpentine-type mineral at 630 °C.<sup>20</sup>

In Table A2 the data from Table A1 are recalculated with the considerations given above, which have a significant influence on the predicted consumption of energy for carbonation of the two serpentine materials:

Case A. refers to the original assessment as reported in Table A1 with all energy inputs calculated as electricity (US\$ 0.05/kWh)

---

<sup>20</sup> Using heat of a temperature  $T$  much higher than this temperature for the pre-treatment will result in significant energy efficiency (*i.e.* exergy,) losses equal to  $(903^{-1} - T^{-1}) \times 100\%$ , which, for example, for  $T = 1600$  K gives  $\sim 5\%$  of the chemical energy of the incoming fuel used. This would lower a 90% efficiency for conversion of chemical energy in the fuel to heat to 85%.

Case B. is based on a cost difference between electricity (US\$ 0.05/kWh) and 630 °C heat (US\$ 0.025 /kWh)

Case C. reduces the time for the thermal pre-treatment from 120 min to 40 min, and all energy inputs calculated as electricity (US\$ 0.05/kWh)

Case D. reduces the time for the thermal pre-treatment from 120 min to 40 min, and a cost difference between electricity (US\$ 0.05/kWh) and 630 °C heat (US\$ 0.025 /kWh)

Table A2. Costs related to energy use for mineral pre-treatment in the ARC study [22,83], assuming US\$ 0.05 /kWh electricity cost, US\$ 0.025/kWh for 630 °C

	#	Power input kWh/t	Heat input kWh/t 630 °C 2 h	A. Costs Heat and Power as electricity US\$/t	B. Costs Heat and Power different US\$/t	Heat input kWh/t 630 °C 40 min	C. Costs Heat and Power as electricity US\$/t,	D. Costs Heat and Power different US\$/t	B/A %	C/A %	D/A %
Olivine	1	13		0.65	0.65		0.65	0.65	100	100	100
100%	2	83		4.15	4.15		4.15	4.15	100	100	100
	3	233		11.65	11.65		11.65	11.65	100	100	100
Serpentine/lizardite	4	13		0.65	0.65		0.65	0.65	100	100	100
100%	5	13	326	16.95	8.80	81.5	6.08	3.37	52	36	20
Olivine	6	19		0.95	0.95		0.95	0.95	100	100	100
70%	7	89		4.45	4.45		4.45	4.45	100	100	100
	8	239		11.95	7.98		7.98	7.98	100	100	100
Serpentine/antigorite	9	13		0.65	0.65		0.65	0.65	100	100	100
100%	10	13	293	15.30	7.98	73.3	5.53	3.09	52	36	20
	11	83	293	18.80	11.48	73.3	9.03	6.59	61	48	35
Wollastonite	12	97		4.85	4.85		4.85	4.85	100	100	100
50%	13	167		8.35	8.35		8.35	8.35	100	100	100

\* Assuming a temperature of the environment  $T_0 = 15\text{ °C} = 288\text{ K}$

The recalculated costs for serpentine carbonation given in Table A2 show that this is not necessarily (much) more expensive or energy intensive than carbonation of the materials that do not require a thermal pre-treatment but may require more mechanical pre-treatment.

**ISSN 0781-982X**

**ISBN 978-952-12-2036-4**

**Åbo Akademis Tryckeri 2008**